



# M\_TTCAN

**Time-triggered Controller Area Network**

**User's Manual**

**Revision 1.01**

**20.12.2010**



**Robert Bosch GmbH**  
Automotive Electronics

## LEGAL NOTICE

© Copyright 2009, 2010 by Robert Bosch GmbH and its licensors. All rights reserved.

"Bosch" is a registered trademark of Robert Bosch GmbH.

The content of this document is subject to continuous developments and improvements. All particulars and its use contained in this document are given by BOSCH in good faith.

NO WARRANTIES: TO THE MAXIMUM EXTENT PERMITTED BY LAW, NEITHER THE INTELLECTUAL PROPERTY OWNERS, COPYRIGHT HOLDERS AND CONTRIBUTORS, NOR ANY PERSON, EITHER EXPRESSLY OR IMPLICITLY, WARRANTS ANY ASPECT OF THIS SPECIFICATION, SOFTWARE RELATED THERETO, CODE AND/OR PROGRAM RELATED THERETO, INCLUDING ANY OUTPUT OR RESULTS OF THIS SPECIFICATION, SOFTWARE RELATED THERETO, CODE AND/OR PROGRAM RELATED THERETO UNLESS AGREED TO IN WRITING. THIS SPECIFICATION, SOFTWARE RELATED THERETO, CODE AND/OR PROGRAM RELATED THERETO IS BEING PROVIDED "AS IS", WITHOUT ANY WARRANTY OF ANY TYPE OR NATURE, EITHER EXPRESS OR IMPLIED, INCLUDING, BUT NOT LIMITED TO, THE IMPLIED WARRANTIES OF MERCHANTABILITY AND FITNESS FOR A PARTICULAR PURPOSE, AND ANY WARRANTY THAT THIS SPECIFICATION, SOFTWARE RELATED THERETO, CODE AND/OR PROGRAM RELATED THERETO IS FREE FROM DEFECTS.

ASSUMPTION OF RISK: THE RISK OF ANY AND ALL LOSS, DAMAGE, OR UNSATISFACTORY PERFORMANCE OF THIS SPECIFICATION (RESPECTIVELY THE PRODUCTS MAKING USE OF IT IN PART OR AS A WHOLE), SOFTWARE RELATED THERETO, CODE AND/OR PROGRAM RELATED THERETO RESTS WITH YOU AS THE USER. TO THE MAXIMUM EXTENT PERMITTED BY LAW, NEITHER THE INTELLECTUAL PROPERTY OWNERS, COPYRIGHT HOLDERS AND CONTRIBUTORS, NOR ANY PERSON EITHER EXPRESSLY OR IMPLICITLY, MAKES ANY REPRESENTATION OR WARRANTY REGARDING THE APPROPRIATENESS OF THE USE, OUTPUT, OR RESULTS OF THE USE OF THIS SPECIFICATION, SOFTWARE RELATED THERETO, CODE AND/OR PROGRAM RELATED THERETO IN TERMS OF ITS CORRECTNESS, ACCURACY, RELIABILITY, BEING CURRENT OR OTHERWISE. NOR DO THEY HAVE ANY OBLIGATION TO CORRECT ERRORS, MAKE CHANGES, SUPPORT THIS SPECIFICATION, SOFTWARE RELATED THERETO, CODE AND/OR PROGRAM RELATED THERETO, DISTRIBUTE UPDATES, OR PROVIDE NOTIFICATION OF ANY ERROR OR DEFECT, KNOWN OR UNKNOWN. IF YOU RELY UPON THIS SPECIFICATION, SOFTWARE RELATED THERETO, CODE AND/OR PROGRAM RELATED THERETO, YOU DO SO AT YOUR OWN RISK, AND YOU ASSUME THE RESPONSIBILITY FOR THE RESULTS. SHOULD THIS SPECIFICATION, SOFTWARE RELATED THERETO, CODE AND/OR PROGRAM RELATED THERETO PROVE DEFECTIVE, YOU ASSUME THE COST OF ALL LOSSES, INCLUDING, BUT NOT LIMITED TO, ANY NECESSARY SERVICING, REPAIR OR CORRECTION OF ANY PROPERTY INVOLVED TO THE MAXIMUM EXTEND PERMITTED BY LAW.

DISCLAIMER: IN NO EVENT, UNLESS REQUIRED BY LAW OR AGREED TO IN WRITING, SHALL THE INTELLECTUAL PROPERTY OWNERS, COPYRIGHT HOLDERS OR ANY PERSON BE LIABLE FOR ANY LOSS, EXPENSE OR DAMAGE, OF ANY TYPE OR NATURE ARISING OUT OF THE USE OF, OR INABILITY TO USE THIS SPECIFICATION, SOFTWARE RELATED THERETO, CODE AND/OR PROGRAM

RELATED THERETO, INCLUDING, BUT NOT LIMITED TO, CLAIMS, SUITS OR CAUSES OF ACTION INVOLVING ALLEGED INFRINGEMENT OF COPYRIGHTS, PATENTS, TRADEMARKS, TRADE SECRETS, OR UNFAIR COMPETITION.

INDEMNIFICATION: TO THE MAXIMUM EXTEND PERMITTED BY LAW YOU AGREE TO INDEMNIFY AND HOLD HARMLESS THE INTELLECTUAL PROPERTY OWNERS, COPYRIGHT HOLDERS AND CONTRIBUTORS, AND EMPLOYEES, AND ANY PERSON FROM AND AGAINST ALL CLAIMS, LIABILITIES, LOSSES, CAUSES OF ACTION, DAMAGES, JUDGMENTS, AND EXPENSES, INCLUDING THE REASONABLE COST OF ATTORNEYS' FEES AND COURT COSTS, FOR INJURIES OR DAMAGES TO THE PERSON OR PROPERTY OF THIRD PARTIES, INCLUDING, WITHOUT LIMITATIONS, CONSEQUENTIAL, DIRECT AND INDIRECT DAMAGES AND ANY ECONOMIC LOSSES, THAT ARISE OUT OF OR IN CONNECTION WITH YOUR USE, MODIFICATION, OR DISTRIBUTION OF THIS SPECIFICATION, SOFTWARE RELATED THERETO, CODE AND/OR PROGRAM RELATED THERETO, ITS OUTPUT, OR ANY ACCOMPANYING DOCUMENTATION.

GOVERNING LAW: THE RELATIONSHIP BETWEEN YOU AND ROBERT BOSCH GMBH SHALL BE GOVERNED SOLELY BY THE LAWS OF THE FEDERAL REPUBLIC OF GERMANY. THE STIPULATIONS OF INTERNATIONAL CONVENTIONS REGARDING THE INTERNATIONAL SALE OF GOODS SHALL NOT BE APPLICABLE. THE EXCLUSIVE LEGAL VENUE SHALL BE DUESSELDORF, GERMANY.

MANDATORY LAW SHALL BE UNAFFECTED BY THE FOREGOING PARAGRAPHS.

INTELLECTUAL PROPERTY OWNERS/COPYRIGHT OWNERS/CONTRIBUTORS: ROBERT BOSCH GMBH, ROBERT BOSCH PLATZ 1, 70839 GERLINGEN, GERMANY AND ITS LICENSORS.



**SPECIFICATION REVISION HISTORY**

<b>REVISION</b>	<b>DATE</b>	<b>NOTES</b>
0.1	23.02.2009	initial working revision
0.2	01.04.2009	first revised working revision
0.3	24.08.2009	second revised working revision
1.0	27.09.2010	first complete revision
1.01	20.12.2010	minor textual enhancements

**TRACKING OF MAJOR CHANGES**

## TERMS AND ABBREVIATIONS

This document uses the following terms and abbreviations.

<b>Term</b>	<b>Meaning</b>
ASC	Asynchronous Communication
BRP	Baud Rate Prescaler
BSP	Bit Stream Processor
BTL	Bit Timing Logic
CAN	Controller Area Network
CRC	Cyclic Redundancy Check
DLC	Data Length Code
ECC	Error Correction Code
EML	Error Management Logic
FSE	Frame Synchronization Entity
FSM	Finite State Machine
MRM	Master Reference Mark
MSC	Message Status Count
NTU	Network Time Unit
TTCAN	Time-Triggered CAN
TUR	Time Unit Ratio

## CONVENTIONS

The following conventions are used within this User's Manual.

<b>Arial bold</b>	Names of bits and ports
<i>Arial italic</i>	States of bits and ports
Reserved	Configuration values marked as reserved are illegal; they are interpreted generally same as reset values.

## REFERENCES

This document refers to the following documents:

<b>Ref</b>	<b>Author(s)</b>	<b>Title</b>
[1]	ISO	ISO 11898-1: CAN data link layer and physical signalling
[2]	ISO	ISO 11898-4: Time-triggered communication
[3]	AE/EIY	M_(TT)CAN System Integration Guide
[4]	AE/EIY	M_TTCAN Module Integration Guide

# Table of contents

1	Overview	1
1.1	Features	1
1.2	Block Diagram	2
1.3	Dual Clock Sources	3
1.4	Dual Interrupt Lines	3
2	Programmer's Model	5
2.1	Hardware Reset Description	5
2.2	Register Map	5
2.3	Registers	7
2.3.1	Customer Register	7
2.3.2	Core Release Register (CREL)	7
2.3.3	Endian Register (ENDN)	8
2.3.4	Test Register (TEST)	8
2.3.5	RAM Watchdog (RWD)	9
2.3.6	CC Control Register (CCCR)	10
2.3.7	Bit Timing & Prescaler Register (BTP)	11
2.3.8	Timestamp Counter Configuration (TSCC)	12
2.3.9	Timestamp Counter Value (TSCV)	12
2.3.10	Timeout Counter Configuration (TOCC)	13
2.3.11	Timeout Counter Value (TOCV)	13
2.3.12	Error Counter Register (ECR)	14
2.3.13	Protocol Status Register (PSR)	14
2.3.14	Interrupt Register (IR)	16
2.3.15	Interrupt Enable (IE)	19
2.3.16	Interrupt Line Select (ILS)	21
2.3.17	Interrupt Line Enable (ILE)	22
2.3.18	Global Filter Configuration (GFC)	23
2.3.19	Standard ID Filter Configuration (SIDFC)	24
2.3.20	Extended ID Filter Configuration (XIDFC)	24
2.3.21	Extended ID AND Mask (XIDAM)	25
2.3.22	High Priority Message Status (HPMS)	25
2.3.23	Rx FIFO 0 Configuration (RXF0C)	26
2.3.24	Rx FIFO 0 Status (RXF0S)	27
2.3.25	Rx FIFO 0 Acknowledge (RXF0A)	28
2.3.26	Rx FIFO 1 Configuration (RXF1C)	28
2.3.27	Rx FIFO 1 Status (RXF1S)	29
2.3.28	Rx FIFO 1 Acknowledge (RXF1A)	30
2.3.29	Tx Buffer Configuration (TXBC)	31
2.3.30	Tx FIFO/Queue Status (TXFQS)	32
2.3.31	Tx Buffer Request Pending (TXBRP)	33
2.3.32	Tx Buffer Add Request (TXBAR)	34
2.3.33	Tx Buffer Cancellation Request (TXBCR)	34
2.3.34	Tx Buffer Transmission Occurred (TXBTO)	35
2.3.35	Tx Buffer Cancellation Finished (TXBCF)	35
2.3.36	Tx Buffer Transmission Interrupt Enable (TXBTIE)	36
2.3.37	Tx Buffer Cancellation Finished Interrupt Enable (TXBCIE)	36
2.3.38	Tx Event FIFO Configuration (TXEFC)	37
2.3.39	Tx Event FIFO Status (TXEFS)	38
2.3.40	Tx Event FIFO Acknowledge (TXEFA)	38
2.3.41	TT Trigger Memory Configuration (TTTMC)	39
2.3.42	TT Reference Message Configuration (TTRMC)	39
2.3.43	TT Operation Configuration (TTOCF)	40
2.3.44	TT Matrix Limits (TTMLM)	41
2.3.45	TUR Configuration (TURCF)	42
2.3.46	TT Operation Control (TTOCN)	43

2.3.47	TT Global Time Preset (TTGTP)	45
2.3.48	TT Time Mark (TTTMK)	46
2.3.49	TT Interrupt Register (TTIR)	47
2.3.50	TT Interrupt Enable (TTIE)	49
2.3.51	TT Interrupt Line Select (TTILS)	50
2.3.52	TT Operation Status (TTOST)	51
2.3.53	TUR Numerator Actual (TURNA)	53
2.3.54	TT Local & Global Time (TTLGT)	53
2.3.55	TT Cycle Time & Count (TTCTC)	54
2.3.56	TT Capture Time (TTCPT)	54
2.3.57	TT Cycle Sync Mark (TTCSM)	55
2.4	Message RAM	56
2.4.1	Message RAM Configuration	56
2.4.2	Rx FIFO Element	57
2.4.3	Tx Buffer Element	58
2.4.4	Tx Event FIFO Element	60
2.4.5	Standard Message ID Filter Element	61
2.4.6	Extended Message ID Filter Element	62
2.4.7	Trigger Memory Element	63
3	Functional Description	65
3.1	Operating Modes	65
3.1.1	Software Initialization	65
3.1.2	Normal Operation	66
3.1.3	Bus Monitoring Mode	66
3.1.4	Disabled Automatic Retransmission	66
3.1.5	Power Down (Sleep Mode)	67
3.1.6	Test Modes	67
3.2	Timestamp Generation	69
3.3	Timeout Counter	69
3.4	Rx Handling	70
3.4.1	Acceptance Filtering	70
3.4.2	Rx FIFOs	74
3.5	Tx Handling	75
3.5.1	Dedicated Tx Buffers	75
3.5.2	Tx FIFO	75
3.5.3	Tx Queue	76
3.5.4	Mixed Dedicated Tx Buffers / Tx FIFO	76
3.5.5	Mixed Dedicated Tx Buffers / Tx Queue	77
3.5.6	Transmit Cancellation	77
3.5.7	Tx Event Handling	78
3.6	FIFO Acknowledge Handling	78
4	TTCAN Operation	79
4.1	Reference Message	79
4.1.1	Level 1	79
4.1.2	Level 2	80
4.1.3	Level 0	80
4.2	TTCAN Configuration	81
4.2.1	TTCAN Timing	81
4.2.2	Message Scheduling	82
4.2.3	Trigger Memory	83
4.2.4	TTCAN Schedule Initialization	87
4.3	TTCAN Gap Control	88
4.4	Stop Watch	90
4.5	Local Time, Cycle Time, Global Time, and External Clock Synchronization	90
4.6	TTCAN Error Level	92
4.7	TTCAN Message Handling	93
4.7.1	Reference Message	93
4.7.2	Message Reception	93
4.7.3	Message Transmission	94

---

4.8	TTCAN Interrupt and Error Handling	96
4.9	Level 0	97
4.9.1	Synchronizing	98
4.9.2	Handling of Error Levels	98
4.9.3	Master Slave Relation	99
4.10	Asynchronous Serial Communication	100
4.11	Synchronization to external Time Schedule	101
5	Appendix	103
5.1	Register Bit Overview	103
5.2	Module Interface	108
5.3	Connection to external Message RAM	109



# Chapter 1.

## 1. Overview

The M\_TTCAN module is the new TTCAN Communication Controller IP-module that can be integrated as stand-alone device or as part of an ASIC. It is described in VHDL on RTL level, prepared for synthesis. The M\_TTCAN performs communication according to ISO 11898-1 (identical to Bosch CAN protocol specification 2.0 part A,B) and according to ISO 11898-4 (Time-triggered communication on CAN). The M\_TTCAN provides all features of time-triggered communication specified in ISO 11898-4, including event synchronized time-triggered communication, global system time, and clock drift compensation.

The message storage is intended to be a single- or dual-ported Message RAM outside of the module. It is connected to the M\_TTCAN via the Generic Master Interface. Depending on the chosen ASIC integration, multiple M\_TTCAN controllers can share the same Message RAM.

All functions concerning the handling of messages are implemented by the Rx Handler and the Tx Handler. The Rx Handler manages message acceptance filtering, the transfer of received messages from the CAN Core to the Message RAM as well as providing receive message status information. The Tx Handler is responsible for the transfer of transmit messages from the Message RAM to the CAN Core as well as providing transmit status information. It implements all functions concerning the time schedule and the global system time.

Acceptance filtering is implemented by a combination of up to 128 filter elements where each one can be configured as a range, as a bit mask, or as a dedicated ID filter.

The M\_TTCAN can be connected to a wide range of Host CPUs via its 8/16/32-bit Generic Slave Interface. The M\_TTCAN's clock domain concept allows the separation between the high precision CAN clock and the Host clock, which may be generated by an FM-PLL.

### 1.1 Features

- Conform with CAN protocol version 2.0 part A, B and ISO 11898-1, -4
- TTCAN protocol level 1 and level 2 completely in hardware
- Event synchronized time-triggered communication supported
- CAN Error Logging
- AUTOSAR optimized
- SAE J1939 optimized
- Improved acceptance filtering
- Two configurable Receive FIFOs
- Separate signalling on reception of High Priority Messages
- Dedicated Transmit Buffers
- Configurable Transmit FIFO / Queue
- Configurable Transmit Event FIFO
- Direct Message RAM access for Host CPU
- Multiple M\_TTCANs may share the same Message RAM
- Programmable loop-back test mode
- Maskable module interrupts
- 8/16/32 bit Generic Slave Interface for connection customer-specific Host CPUs
- Two clock domains (CAN clock and Host clock)
- Power-down support

## 1.2 Block Diagram

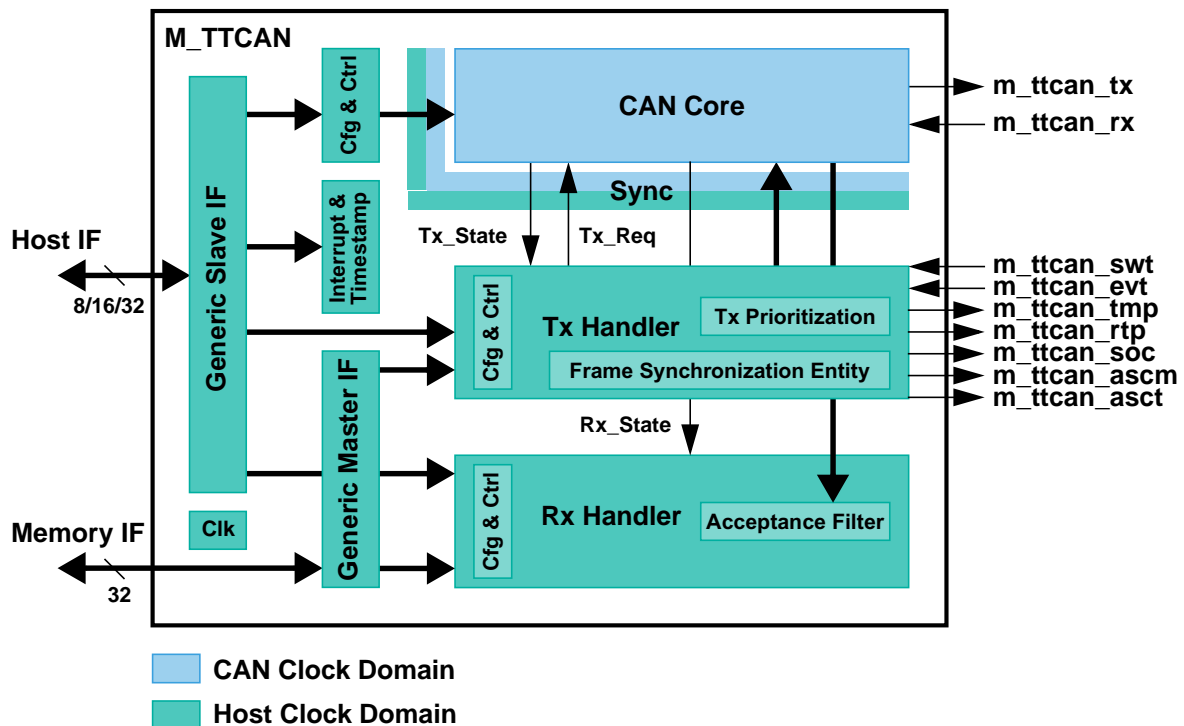

Figure 1 M\_TTCAN Block Diagram

### CAN Core

CAN Protocol Controller and Rx/Tx Shift Register. Handles all ISO 11898-1 protocol functions. Supports 11-bit and 29-bit identifiers.

### Sync

Synchronizes signals from the Host clock domain to the CAN clock domain and vice versa.

### Cfg & Ctrl

CAN Core related configuration and control bits.

### Interrupt & Timestamp

Interrupt control and 16-bit CAN bit time counter for receive and transmit timestamp generation. An externally generated 16-bit vector may substitute the integrated 16-bit CAN bit time counter for receive and transmit timestamp generation.

### Tx Handler

Controls the message transfer from the external Message RAM to the CAN Core. A maximum of 32 Tx Buffers can be configured for transmission. Tx buffers can be used as dedicated Tx Buffers, as Tx FIFO, part of a Tx Queue, or as a combination of them. A Tx Event FIFO stores Tx timestamps together with the corresponding Message ID. Transmit cancellation is also supported.

The Tx Handler also implements the Frame Synchronization Entity FSE which controls time-triggered communication according to ISO11898-4. It synchronizes itself to the reference messages on the CAN bus, controls cycle time and global time, and handles transmissions according to the predefined message schedule, the system matrix. It also handles the time marks of the system matrix that are linked to the messages in the Message RAM. Stop Watch Trigger, Event Trigger, and Time Mark Interrupt are synchronization interfaces.

### Rx Handler

Controls the transfer of received messages from the CAN Core to the external Message RAM. The Rx Handler supports two Receive FIFOs, each of configurable size, holding all messages that have passed acceptance filtering. An Rx timestamp is stored together with each message. Up to 128 filters can be defined for 11-bit IDs and up to 64 filters for 29-bit IDs.

### Clk

Synchronizes reset signal to the Host clock domain and to the CAN clock domain.

### Generic Slave Interface

Connects the M\_TTCAN to a customer specific Host CPU. The Generic Slave Interface is capable to connect to an 8/16/32-bit bus to support a wide range of interconnection structures.

### Generic Master Interface

Connects the M\_TTCAN access to an external 32-bit Message RAM. The maximum Message RAM size is 16K • 32 bit.

## 1.3 Dual Clock Sources

To improve the EMC behavior, a spread spectrum clock can be used for the Host clock domain **m\_ttcan\_hclk**. Due to the high precision clocking requirements of the CAN Core, a separate clock without any modulation has to be provided as **m\_ttcan\_cclk**. The CAN Core should be programmed to have at least 8 clocks per bittime, this is e.g. 1 Mbaud @ **m\_ttcan\_cclk** >= 8 MHz. Even in case of a very high Host clock frequency, the clock frequency of the CAN Core needs not to be higher than 8 MHz.

Within the M\_TTCAN module there is a synchronization mechanism implemented to ensure save data transfer between the two clock domains.

**Note: In order to achieve a stable function of the M\_TTCAN, the Host clock must always be faster than or equal to the CAN clock. Also the modulation depth of the spread spectrum clock has to be regarded.**

## 1.4 Dual Interrupt Lines

The module provides two interrupt lines. Interrupts can be routed either to **m\_ttcan\_int0** or to **m\_ttcan\_int1**. By default all interrupts are routed to interrupt line **m\_ttcan\_int0**. By programming **ILE.EINT0** and **ILE.EINT1** the interrupt lines can be enabled or disabled separately.



# Chapter 2.

## 2. Programmer's Model

### 2.1 Hardware Reset Description

After hardware reset, the registers of the M\_TTCAN hold the reset values listed in Table 1. Additionally the *Bus\_Off* state is reset and the output **m\_ttcn\_tx** is set to *recessive* (HIGH). The value 0x0001 (**CCCR.INIT** = '1') in the CC Control Register enables software initialization. The M\_TTCAN does not influence the CAN bus until the CPU resets **CCCR.INIT** to '0'.

### 2.2 Register Map

The M\_TTCAN module allocates an address space of 512 bytes. All registers are organized as 32-bit registers. The M\_TTCAN is accessible by the Host CPU via the Generic Slave Interface using a data width of 8 bit (byte access), 16 bit (half-word access), or 32 bit (word access). Write access by the Host CPU to registers/bits marked with "P=Protected Write" is possible only with **CCCR.CCE**='1' AND **CCCR.INIT**='1'. There is a delay from writing to a command register until the update of the related status register bits due to clock domain crossing.

ADDRESS	SYMBOL	NAME	PAGE	RESET	ACC
0x000	CREL	Core Release Register	7	rrrd dddd	R
0x004	ENDN	Endian Register	8	8765 4321	R
0x008	CUST	Customer Register	7	t.b.d.	t.b.d.
0x00C		<i>reserved (1)</i>		0000 0000	R
0x010	TEST	Test Register	8	0000 00u0	RP
0x014	RWD	RAM Watchdog	9	0000 0000	RP
0x018	CCCR	CC Control Register	10	0000 0001	RP
0x01C	BTP	Bit Timing & Prescaler Register	11	0000 2301	RP
0x020	TSCC	Timestamp Counter Configuration	12	0000 0000	RP
0x024	TSCV	Timestamp Counter Value	12	0000 0000	RC
0x028	TOCC	Timeout Counter Configuration	13	FFFF 0000	RP
0x02C	TOCV	Timeout Counter Value	13	0000 FFFF	RC
0x030-03C		<i>reserved (4)</i>		0000 0000	R
0x040	ECR	Error Counter Register	14	0000 0000	R
0x044	PSR	Protocol Status Register	14	0000 0007	RS
0x048-04C		<i>reserved (2)</i>		0000 0000	R
0x050	IR	Interrupt Register	16	0000 0000	RW
0x054	IE	Interrupt Enable	19	0000 0000	RW
0x058	ILS	Interrupt Line Select	21	0000 0000	RW
0x05C	ILE	Interrupt Line Enable	22	0000 0000	RW
0x060-07C		<i>reserved (8)</i>		0000 0000	R
0x080	GFC	Global Filter Configuration	23	0000 0000	RP
0x084	SIDFC	Standard ID Filter Configuration	24	0000 0000	RP
0x088	XIDFC	Extended ID Filter Configuration	24	0000 0000	RP
0x08C		<i>reserved (1)</i>		0000 0000	R
0x090	XIDAM	Extended ID AND Mask	25	1FFF FFFF	RP
0x094	HPMS	High Priority Message Status	25	0000 0000	R

Table 1 M\_TTCAN Register Map

ADDRESS	SYMBOL	NAME	PAGE	RESET	ACC
0x098-09C		<i>reserved (2)</i>		0000 0000	R
0x0A0	RXF0C	Rx FIFO 0 Configuration	26	0000 0000	RP
0x0A4	RXF0S	Rx FIFO 0 Status	27	0000 0000	R
0x0A8	RXF0A	Rx FIFO 0 Acknowledge	28	0000 0000	RW
0x0AC		<i>reserved (1)</i>		0000 0000	R
0x0B0	RXF1C	Rx FIFO 1 Configuration	28	0000 0000	RP
0x0B4	RXF1S	Rx FIFO 1 Status	29	0000 0000	R
0x0B8	RXF1A	Rx FIFO 1 Acknowledge	30	0000 0000	RW
0x0BC		<i>reserved (1)</i>		0000 0000	R
0x0C0	TXBC	Tx Buffer Configuration	31	0000 0000	RP
0x0C4	TXFQS	Tx FIFO/Queue Status	32	0000 0000	R
0x0C8		<i>reserved (1)</i>		0000 0000	R
0x0CC	TXBRP	Tx Buffer Request Pending	33	0000 0000	R
0x0D0	TXBAR	Tx Buffer Add Request	34	0000 0000	RW
0x0D4	TXBCR	Tx Buffer Cancellation Request	34	0000 0000	RW
0x0D8	TXBTO	Tx Buffer Transmission Occurred	35	0000 0000	R
0x0DC	TXBCF	Tx Buffer Cancellation Finished	35	0000 0000	R
0x0E0	TXBTIE	Tx Buffer Transmission Interrupt Enable	36	0000 0000	RW
0x0E4	TXBCIE	Tx Buffer Cancellation Finished Interrupt Enable	36	0000 0000	RW
0x0E8-0EC		<i>reserved (2)</i>		0000 0000	R
0x0F0	TXEFC	Tx Event FIFO Configuration	37	0000 0000	RP
0x0F4	TXEFS	Tx Event FIFO Status	38	0000 0000	R
0x0F8	TXEFA	Tx Event FIFO Acknowledge	38	0000 0000	RW
0x0FC		<i>reserved (1)</i>		0000 0000	R
0x100	TTTMC	TT Trigger Memory Configuration	39	0000 0000	RP
0x104	TTRMC	TT Reference Message Configuration	39	0000 0000	RP
0x108	TTOCF	TT Operation Configuration	40	0001 0000	RP
0x10C	TTMLM	TT Matrix Limits	41	0000 0000	RP
0x110	TURCF	TUR Configuration	42	1000 0000	RP
0x114	TTOCN	TT Operation Control	43	0000 0000	RW
0x118	TTGTP	TT Global Time Preset	45	0000 0000	RW
0x11C	TTTMK	TT Time Mark	46	0000 0000	RW
0x120	TTIR	TT Interrupt Register	47	0000 0000	RW
0x124	TTIE	TT Interrupt Enable	49	0000 0000	RW
0x128	TTILS	TT Interrupt Line Select	50	0000 0000	RW
0x12C	TTOST	TT Operation Status	51	0000 0080	R
0x130	TURNA	TUR Numerator Actual	53	0001 0000	R
0x134	TTLGT	TT Local & Global Time	53	0000 0000	R
0x138	TTCTC	TT Cycle Time & Count	54	003F 0000	R
0x13C	TTCPT	TT Capture Time	54	0000 0000	R
0x140	TTCSM	TT Cycle Sync Mark	55	0000 0000	R
0x144-1FC		<i>reserved (47)</i>		0000 0000	R

R = Read, S = Set on read, W = Write, P = Protected Write, C = Clear/preset on write, r = release, d = date, u = undefined

Table 1 M\_TTCAN Register Map

## 2.3 Registers

### 2.3.1 Customer Register

Address 0x08 is reserved for an optional 32 bit customer-specific register. The Customer Register is intended to hold customer-specific configuration, control, and status bits. A description of the functionality is not part of this document.

### 2.3.2 Core Release Register (CREL)

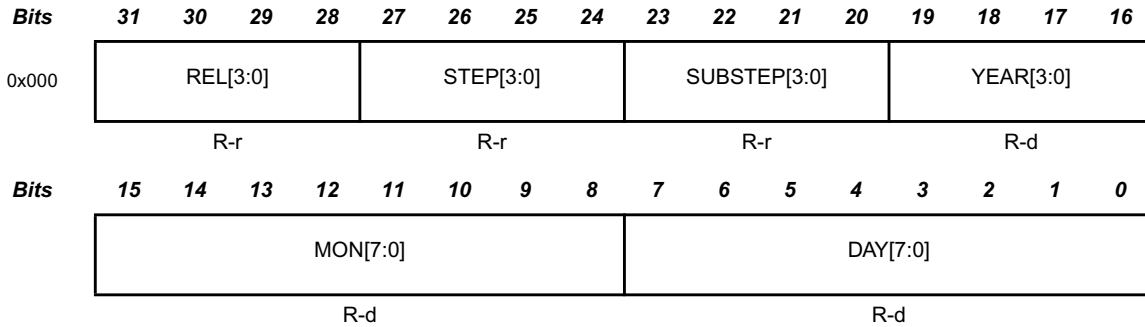

R = Read; -r = release, -d = time stamp, value defined at synthesis by generic parameter

Table 2 Core Release Register (addresses 0x000)

**Bits 31:28 REL[3:0]:** Core Release

One digit, BCD-coded.

**Bits 27:24 STEP[3:0]:** Step of Core Release

One digit, BCD-coded.

**Bits 23:20 SUBSTEP[3:0]:** Sub-step of Core Release

One digit, BCD-coded.

**Bits 19:16 YEAR[3:0]:** Time Stamp Year

One digit, BCD-coded. This field is set by generic parameter on M\_TTCAN synthesis.

**Bits 15:8 MON[7:0]:** Time Stamp Month

Two digits, BCD-coded. This field is set by generic parameter on M\_TTCAN synthesis.

**Bits 7:0 DAY[7:0]:** Time Stamp Day

Two digits, BCD-coded. This field is set by generic parameter on M\_TTCAN synthesis.

Release	Step	SubStep	Year	Month	Day	Name
0	1	0	0	03	10	Revision 0.1.0, Date 2010/03/10

Table 3 Example for Coding of Revisions

### 2.3.3 Endian Register (ENDN)

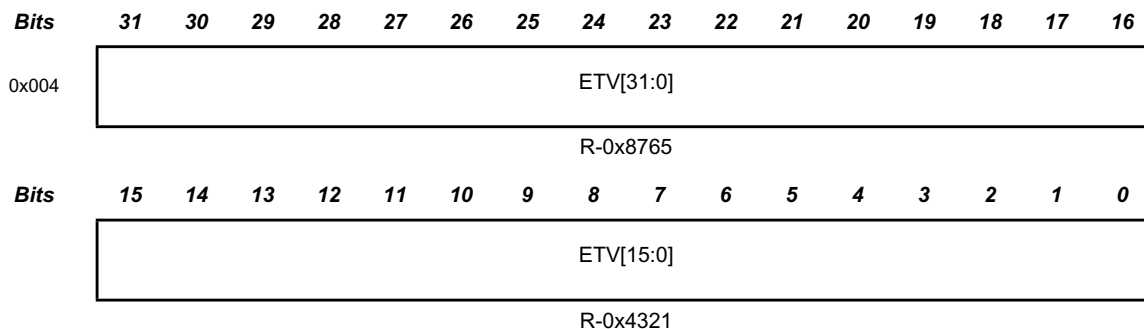

R = Read; -t = test value

Table 4 Endian Register (address 0x004)

**Bits 31:0 ETV[31:0]:** Endianness Test Value

The endianness test value is 0x87654321.

### 2.3.4 Test Register (TEST)

Write access to the Test Register has to be enabled by setting bit **CCCR.TEST** to '1'. All Test Register functions are set to their reset values when bit **CCCR.TEST** is reset.

Loop Back Mode and software control of pin **m\_ttcn\_tx** are hardware test modes. Programming of **TX** ≠ "00" may disturb the message transfer on the CAN bus.

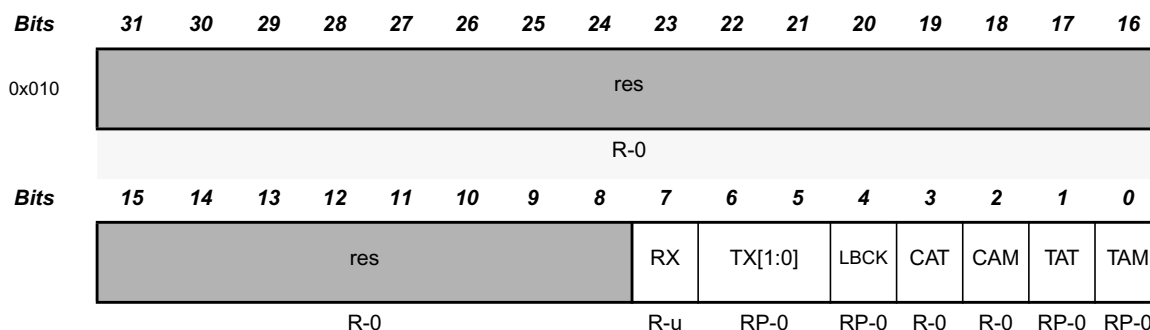

R = Read, P = Protected write, -u = undefined; -n = value after reset

Table 5 Test Register (address 0x010)

**Bit 7 RX:** Receive Pin

Monitors the actual value of pin **m\_ttcn\_rx**

0= The CAN bus is dominant (**m\_ttcn\_rx** = '0')

1= The CAN bus is recessive (**m\_ttcn\_rx** = '1')

**Bits 6:5 TX[1:0]:** Control of Transmit Pin

00 Reset value, **m\_ttcn\_tx** is controlled by the CAN Core, updated at the end of the CAN bit time

01 Sample Point can be monitored at pin **m\_ttcn\_tx**

10 Dominant ('0') level at pin **m\_ttcn\_tx**

11 Recessive ('1') at pin **m\_ttcn\_tx**

**Bit 4 LBCK:** Loop Back Mode

0= Reset value, Loop Back Mode is disabled

1= Loop Back Mode is enabled (see Section 3.1.6, *Test Modes*)

**Bit 3 CAT:** Check ASC Transmit Control

Monitors level at output pin **m\_ttcan\_asct**.

0= Output pin **m\_ttcan\_asct** = '0'

1= Output pin **m\_ttcan\_asct** = '1'

**Bit 2 CAM:** Check ASC Multiplexer Control

Monitors level at output pin **m\_ttcan\_ascm**.

0= Output pin **m\_ttcan\_ascm** = '0'

1= Output pin **m\_ttcan\_ascm** = '1'

**Bit 1 TAT:** Test ASC Transmit Control

Controls output pin **m\_ttcan\_asct** in test mode, ORed with the signal from the FSE

0= Level at pin **m\_ttcan\_asct** controlled by FSE

1= Level at pin **m\_ttcan\_asct** = '1'

**Bit 0 TAM:** Test ASC Multiplexer Control

Controls output pin **m\_ttcan\_ascm** in test mode, ORed with the signal from the FSE

0= Level at pin **m\_ttcan\_ascm** controlled by FSE

1= Level at pin **m\_ttcan\_ascm** = '1'

**2.3.5 RAM Watchdog (RWD)**

The RAM Watchdog monitors the READY output of the Message RAM (**m\_can\_aeim\_ready**). A Message RAM access via the M\_CAN's Generic Master Interface (**m\_can\_aeim\_sel** active) starts the Message RAM Watchdog Counter with the value configured by **RWD.WDC**. The counter is reloaded with **RWD.WDC** when the Message RAM signals successful completion by activating its READY output. In case there is no response from the Message RAM until the counter has counted down to zero, the counter stops and interrupt flag **IR.WDI** is set. The RAM Watchdog Counter is clocked by the Host clock (**m\_can\_hclk**).

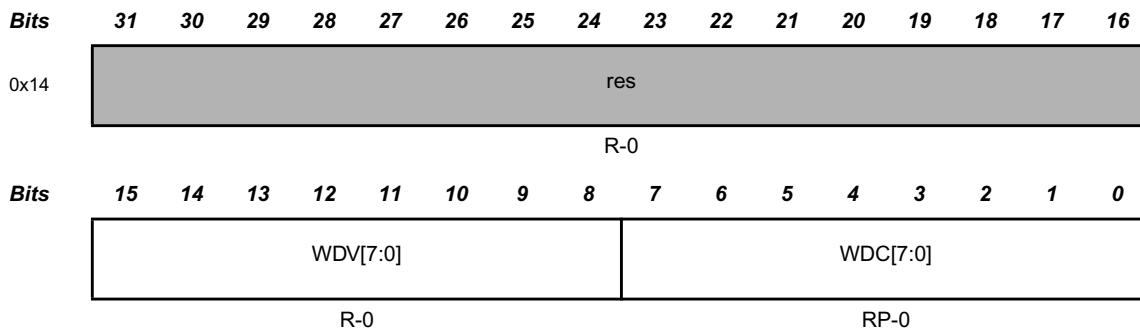

R = Read, W = Write, P = Protected write; -n = value after reset

**Table 6** RAM Watchdog (address 0x14)

**Bits 15:8 WDV[7:0]:** Watchdog Value

Actual Message RAM Watchdog Counter Value.

**Bits 7:0 WDC[7:0]:** Watchdog Configuration

Start value of the Message RAM Watchdog Counter. With the reset value of "00" the counter is disabled.

### 2.3.6 CC Control Register (CCCR)

For details about setting and resetting of single bits see Section 3.1.1.

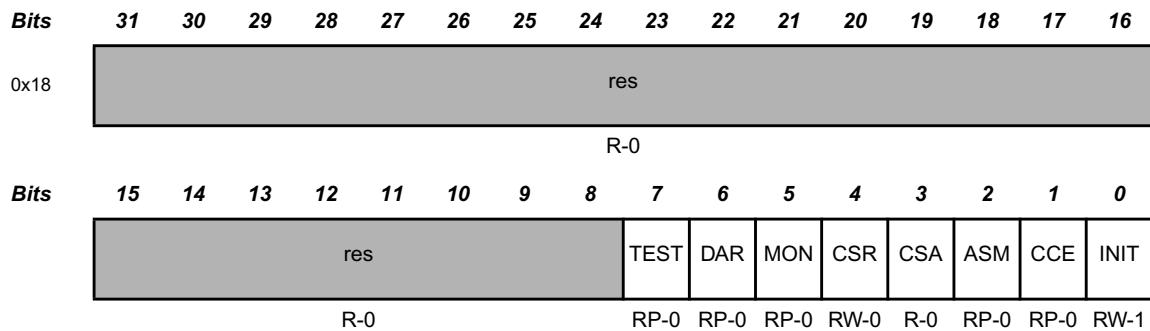

R = Read, W = Write, P = Protected write; -n = value after reset

Table 7 CC Control Register (address 0x18)

- Bit 7 TEST:** Test Mode Enable
- 0= Normal operation, register **TEST** holds reset values
  - 1= Test Mode, write access to register **TEST** enabled
- Bit 6 DAR:** Disable Automatic Retransmission
- 0= Automatic retransmission of messages not transmitted successfully enabled
  - 1= Automatic retransmission disabled
- Bit 5 MON** Bus Monitoring Mode
- When TTCAN Level 1,2 operation is configured and the M\_TTCAN is in error level S3 (**TTOST.EL** = "11"), bit **MON** is set to '1' and bus monitoring mode is entered. Bit **MON** can only be set by the Host when both **CCE** and **INIT** are set to '1'. When the internal set condition is not active, the bit can be reset by the Host at any time.
- 0= Bus Monitoring Mode is disabled
  - 1= Bus Monitoring Mode is enabled
- Bit 4 CSR:** Clock Stop Request
- 0= No clock stop is requested
  - 1= Clock stop requested. When clock stop is requested, first **INIT** and then **CSA** will be set after all pending transfer requests have been completed and the CAN bus reached *idle*.
- Bit 3 CSA:** Clock Stop Acknowledge
- 0= No clock stop acknowledged
  - 1= M\_TTCAN may be set in power down by stopping **m\_ttcan\_hclk** and **m\_ttcan\_cclk**
- Bit 2 ASM** Restricted Operation Mode for Asynchronous Serial Operation
- To use the Asynchronous Serial Communication (see Section 4.10), the Host has to set **ASM** during initialization. Bit **ASM** is reset at the end of the first ASC window after the M\_TTCAN has finished initializing. Bit **ASM** can only be set by the Host when both **CCE** and **INIT** are set to '1'. The bit can be reset by the Host at any time (see Section 4.10).
- 0= Normal (TT)CAN operation
  - 1= During startup for ASC@CAN operation or during ASC windows
- Bit 1 CCE:** Configuration Change Enable
- 0= The CPU has no write access to the protected configuration registers
  - 1= The CPU has write access to the protected configuration registers (while **CCCR.INIT** = '1')

**Bit 0 INIT:** Initialization

0= Normal Operation

1= Initialization is started

**Note:** Due to the synchronization mechanism between the two clock domains, there may be a delay until the value written to INIT can be read back. Therefore the programmer has to assure that the previous value written to INIT has been accepted by reading INIT before setting INIT to a new value.

### 2.3.7 Bit Timing & Prescaler Register (BTP)

This register is only writable if bits **CCCR.CCE** and **CCCR.INIT** are set. The CAN bit time may be programmed in the range of [4...25] time quanta. The CAN time quantum may be programmed in the range of [1...1024] **m\_ttcn\_cclk** periods.

$t_q = (BRP + 1) \text{ m\_ttcan\_cclk period, where } BRP = (0x40 \bullet BRPE) + BRPL.$

**TSEG1** is the sum of Prop\_Seg and Phase\_Seg1. **TSEG2** is Phase\_Seg2.

Therefore the length of the bit time is (programmed values) **[TSEG1 + TSEG2 + 3] t<sub>q</sub>**  
or (functional values) **[Sync\_Seg + Prop\_Seg + Phase\_Seg1 + Phase\_Seg2] t<sub>q</sub>**.

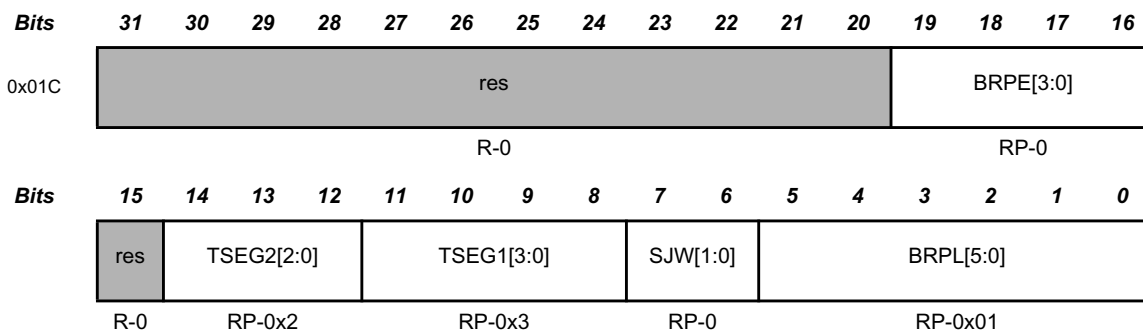

R = Read, P = Protected write; -n = value after reset

Table 8 Bit Timing & Prescaler Register (address 0x01C)

**Bits 19:16 BRPE[3:0]:** Baud Rate Prescaler Extension

0x0-0xF By programming **BRPE** the Baud Rate Prescaler can be extended to values up to 1023.

**Bits 14:12 TSEG2[2:0]:** The time segment after the sample point

0x0-0x7 valid values for TSeg2 are [0...7].

**Bits 11:8 TSEG1[3:0]:** The time segment before the sample point

0x1-0xF valid values for TSeg1 are [1...15].

**Bits 7:6 SJW[1:0]:** (Re) Synchronization Jump Width

0x0-0x3 valid programmed values are 0-3. The actual interpretation by the hardware of this value is such that one more than the value programmed here is used

**Bits 5:0 BRPL[5:0]:** Baud Rate Prescaler Low

0x00-0x3F The value by which the oscillator frequency is divided for generating the bit time quanta. The bit time is built up from a multiple of this quanta. Valid values for the Baud Rate Prescaler are [0...63]. The actual interpretation by the hardware of this value is such that one more than the value programmed here is used.

**Note:** With a CAN clock (**m\_ttcn\_cclk**) of 8 MHz, the reset value of 0x00002301 configures the **M\_TTCAN** for a bit rate of 500 kBit/s.

### 2.3.8 Timestamp Counter Configuration (TSCC)

For a description of the Timestamp Counter see Section 3.2, *Timestamp Generation*.

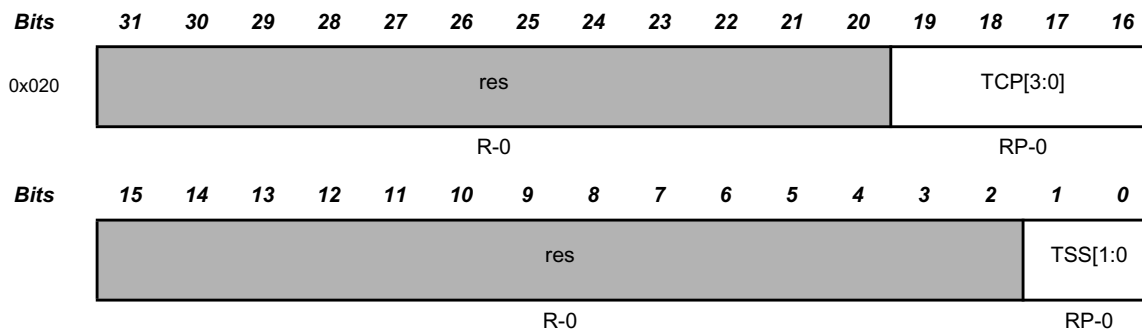

R = Read, P = Protected write; -n = value after reset

Table 9 Timestamp Counter Configuration (address 0x020)

**Bit 19:16 TCP[3:0]:** Timestamp Counter Prescaler

0x0-0xF Configures the timestamp and timeout counters time unit in multiples of CAN bit times [1...16]. The actual interpretation by the hardware of this value is such that one more than the value programmed here is used.

**Bits 1:0 TSS[1:0]:** Timestamp Select

00= Timestamp counter value always 0x0000

01= Timestamp counter value incremented according to **TCP**

10= External timestamp counter value used

11= Same as "00"

### 2.3.9 Timestamp Counter Value (TSCV)

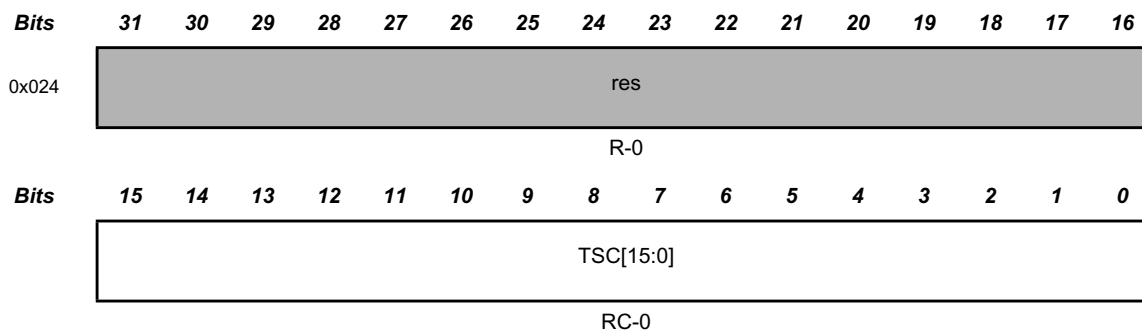

R = Read, C = Clear on write; -n = Value after reset

Table 10 Timestamp Counter Value (address 0x024)

**Bit 15:0 TSC[15:0]:** Timestamp Counter

The internal/external Timestamp Counter value is captured on start of frame (both Rx and Tx). When **TSCC.TSS** = "01", the Timestamp Counter is incremented in multiples of CAN bit times [1...16] depending on the configuration of **TSCC.TCP**. A wrap around sets interrupt flag **IR.TSW**. Write access resets the counter to zero. When **TSCC.TSS** = "10", **TSC** reflects the external Timestamp Counter value. A write access has no impact.

**Note:** A "wrap around" is a change of the Timestamp Counter value from non-zero to zero not caused by write access to **TSCV**.

### 2.3.10 Timeout Counter Configuration (TOCC)

For a description of the Timeout Counter see Section 3.3, *Timeout Counter*.

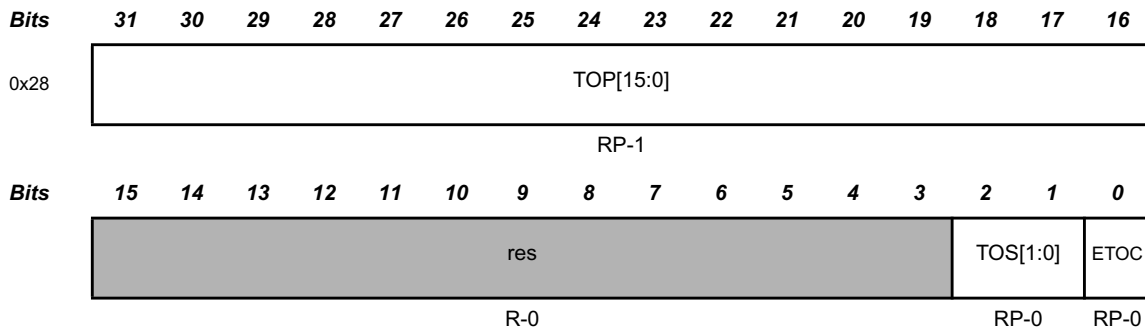

R = Read, P = Protected write; -n = value after reset

Table 11 Timeout Counter Configuration (address 0x28)

**Bit 31:16 TOP[15:0]:** Timeout Period

Start value of the Timeout Counter (down-counter). Configures the Timeout Period.

**Bits 2:1 TOS[1:0]:** Timeout Select

When operating in Continuous mode, a write to **TOCV** presets the counter to the value configured by **TOCC.TOP** and continues down-counting. When the Timeout Counter is controlled by one of the FIFOs, an empty FIFO presets the counter to the value configured by **TOCC.TOP**. Down-counting is started when the first FIFO element is stored.

00= Continuous operation

01= Timeout controlled by Tx Event FIFO

10= Timeout controlled by Rx FIFO 0

11= Timeout controlled by Rx FIFO 1

**Bit 0 ETOC:** Enable Timeout Counter

0= Timeout Counter disabled

1= Timeout Counter enabled

### 2.3.11 Timeout Counter Value (TOCV)

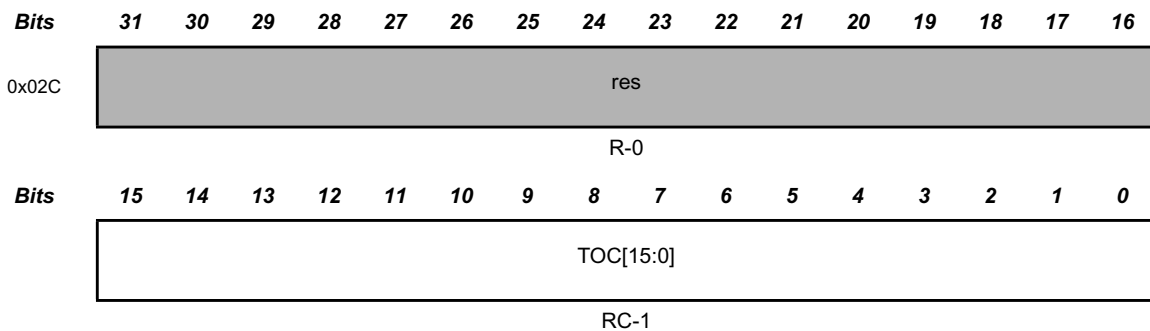

R = Read, C = Clear on write; -n = value after reset

Table 12 Timeout Counter Value (address 0x02C)

**Bit 15:0 TOC[15:0]:** Timeout Counter

The Timeout Counter is decremented in multiples of CAN bit times [1...16] depending on the configuration of **TSCC.TCP**. When decremented to zero, interrupt flag **IR.TOO** is set and the Timeout Counter is stopped. Start and reset/restart conditions are configured via **TOCC.TOS**.

**2.3.12 Error Counter Register (ECR)**

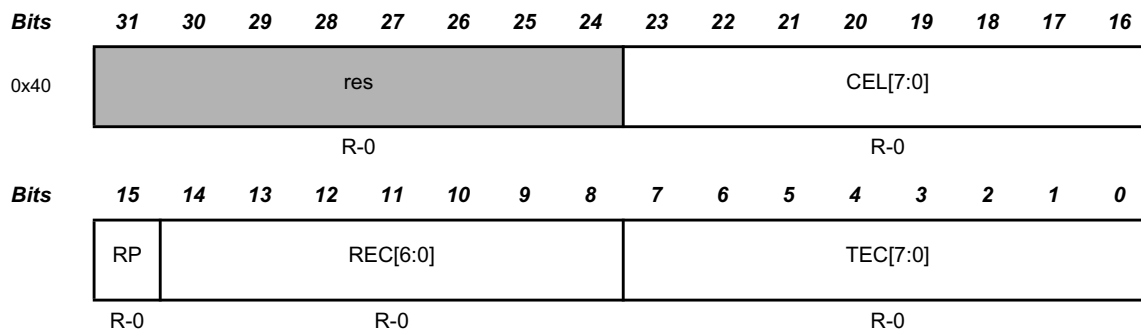

R = Read; -n = value after reset

Table 13 Error Counter Register (address 0x40)

**Bits 23:16 CEL[7:0]:** CAN Error Logging

The counter is incremented each time when a CAN protocol error causes the Transmit Error Counter or the Receive Error Counter to be incremented. It is reset by read access to **CEL**. The counter stops at 0xFF; the next increment of **TEC** or **REC** sets interrupt flag **IR.ELO**.

**Bit 15 RP:** Receive Error Passive

- 0= The Receive Error Counter is below the *error passive* level of 128
- 1= The Receive Error Counter has reached the *error passive* level of 128

**Bits 14:8 REC[6:0]:** Receive Error Counter

Actual state of the Receive Error Counter, values between 0 and 127

**Bits 7:0 TEC[7:0]:** Transmit Error Counter

Actual state of the Transmit Error Counter, values between 0 and 255

**2.3.13 Protocol Status Register (PSR)**

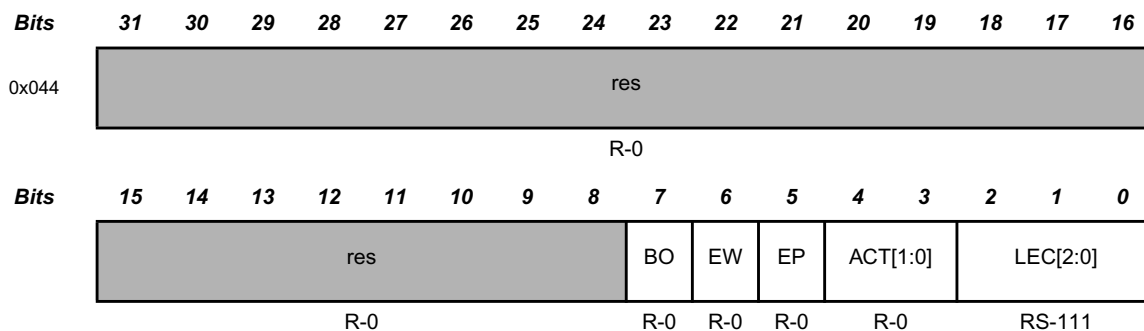

R = Read, S = Set on read; -n = value after reset

Table 14 Protocol Status Register (address 0x044)

**Bit 7 BO:** Bus\_Off Status

- 0= The M\_TTCAN is not Bus\_Off
- 1= The M\_TTCAN is in Bus\_Off state

**Bit 6 EW:** Warning Status

- 0= Both error counters are below the Error\_Warning limit of 96
- 1= At least one of error counter has reached the Error\_Warning limit of 96

**Bit 5**      **EP:**      Error Passive

- 0= The M\_TTCAN is in the Error\_Active state. It normally takes part in bus communication and sends an active error flag when an error has been detected
- 1= The M\_TTCAN is in the Error\_Passive state

**Bits 4:3**      **ACT[1:0]:** Activity

Monitors the module's CAN communication state.

- 00= Synchronizing - node is synchronizing on CAN communication
- 01= Idle - node is neither receiver nor transmitter
- 10= Receiver - node is operating as receiver
- 11= Transmitter - node is operating as transmitter

**Bits 2:0**      **LEC[2:0]:** Last Error Code

The **LEC** indicates the type of the last error to occur on the CAN bus. This field will be cleared to '0' when a message has been transferred (reception or transmission) without error.

- 0= **No Error:** No error occurred since **LEC** has been reset by successful reception or transmission.
- 1= **Stuff Error:** More than 5 equal bits in a sequence have occurred in a part of a received message where this is not allowed.
- 2= **Form Error:** A fixed format part of a received frame has the wrong format.
- 3= **AckError:** The message transmitted by the M\_TTCAN was not acknowledged by another node.
- 4= **Bit1Error:** During the transmission of a message (with the exception of the arbitration field), the device wanted to send a *recessive* level (bit of logical value '1'), but the monitored bus value was *dominant*.
- 5= **Bit0Error:** During the transmission of a message (or acknowledge bit, or active error flag, or overload flag), the device wanted to send a *dominant* level (data or identifier bit logical value '0'), but the monitored bus value was *recessive*. During *Bus\_Off* recovery this status is set each time a sequence of 11 *recessive* bits has been monitored. This enables the CPU to monitor the proceeding of the *Bus\_Off* recovery sequence (indicating the bus is not stuck at *dominant* or continuously disturbed).
- 6= **CRCError:** The CRC check sum of a received message was incorrect. The CRC of an incoming message does not match with the CRC calculated from the received data.
- 7= **NoChange:** Any read access to the Protocol Status Register re-initializes the **LEC** to '7'. When the **LEC** shows the value '7', no CAN bus event was detected since the last CPU read access to the Protocol Status Register.

**Note:** *The Bus\_Off recovery sequence (see CAN Specification Rev. 2.0 or ISO11898-1) cannot be shortened by setting or resetting CCCR.INIT. If the device goes Bus\_Off, it will set CCCR.INIT of its own accord, stopping all bus activities. Once CCCR.INIT has been cleared by the CPU, the device will then wait for 129 occurrences of Bus Idle (129 \* 11 consecutive recessive bits) before resuming normal operation. At the end of the Bus\_Off recovery sequence, the Error Management Counters will be reset. During the waiting time after the resetting of CCCR.INIT, each time a sequence of 11 recessive bits has been monitored, a Bit0Error code is written to PSR.LEC, enabling the CPU to readily check up whether the CAN bus is stuck at dominant or continuously disturbed and to monitor the Bus\_Off recovery sequence. ECR.REC is used to count these sequences.*

### 2.3.14 Interrupt Register (IR)

The flags are set when one of the listed conditions is detected (edge-sensitive). The flags remain set until the Host clears them. A flag is cleared by writing a '1' to the corresponding bit position. Writing a '0' has no effect. A hard reset will clear the register. The configuration of **IE** controls whether an interrupt is generated. The configuration of **ILS** controls on which interrupt line an interrupt is signalled.

<b>Bits</b>	<b>31</b>	<b>30</b>	<b>29</b>	<b>28</b>	<b>27</b>	<b>26</b>	<b>25</b>	<b>24</b>	<b>23</b>	<b>22</b>	<b>21</b>	<b>20</b>	<b>19</b>	<b>18</b>	<b>17</b>	<b>16</b>
0x50	STE	FOE	ACKE	BE	CRCE	WDI	BO	EW	EP	ELO	BEU	BEC	res	TOO	UMD	TSW
	RW-0	RW-0	RW-0	RW-0	RW-0	RW-0	RW-0	RW-0	RW-0	RW-0	RW-0	RW-0	R-0	RW-0	RW-0	RW-0
<b>Bits</b>	<b>15</b>	<b>14</b>	<b>13</b>	<b>12</b>	<b>11</b>	<b>10</b>	<b>9</b>	<b>8</b>	<b>7</b>	<b>6</b>	<b>5</b>	<b>4</b>	<b>3</b>	<b>2</b>	<b>1</b>	<b>0</b>
	TEFL	TEFF	TEFW	TEFN	TFE	TCF	TC	HPM	RF1L	RF1F	RF1W	RF1N	RF0L	RF0F	RF0W	RF0N
	RW-0	RW-0	RW-0	RW-0	RW-0	RW-0	RW-0	RW-0	RW-0	RW-0	RW-0	RW-0	RW-0	RW-0	RW-0	RW-0

R = Read, W = Write; -n = value after reset

Table 15 Interrupt Register (address 0x50)

- Bit 31 STE:** Stuff Error  
 0= No Stuff Error detected  
 1= More than 5 equal bits in a sequence occurred
- Bit 30 FOE:** Format Error  
 0= No Format Error detected  
 1= A fixed format part of a received frame has the wrong format
- Bit 29 ACKE:** Acknowledge Error  
 0= No Acknowledge Error detected  
 1= A transmitted message was not acknowledged by another node
- Bit 28 BE:** Bit Error  
 0= No Bit Error detected  
 1= Device wanted to send a *rec / dom* level, but monitored bus level was *dom / rec*
- Bit 27 CRCE:** CRC Error  
 0= No CRC Error detected  
 1= Received CRC did not match the calculated CRC
- Bit 26 WDI:** Watchdog Interrupt  
 0= No Message RAM Watchdog event occurred  
 1= Message RAM Watchdog event due to missing READY
- Bit 25 BO:** Bus\_Off Status  
 0= Bus\_Off status unchanged  
 1= Bus\_Off status changed
- Bit 24 EW:** Warning Status  
 0= Error\_Warning status unchanged  
 1= Error\_Warning status changed

**Bit 23 EP:** Error Passive

0= Error\_Passive status unchanged

1= Error\_Passive status changed

**Bit 22 ELO:** Error Logging Overflow

0= CAN Error Logging Counter did not overflow

1= Overflow of CAN Error Logging Counter occurred

**Bit 21 BEU:** Bit Error Uncorrected

Message RAM bit error detected, uncorrected. Controlled by input signal **m\_ttcn\_aeim\_berr[1]** generated by an optional external parity / ECC logic attached to the Message RAM. An uncorrected Message RAM bit error sets **CCCR.INIT** to '1'. This is done to avoid transmission of corrupted data.

0= No bit error detected when reading from Message RAM

1= Bit error detected, uncorrected (e.g. parity logic)

**Bit 20 BEC:** Bit Error Corrected

Message RAM bit error detected and corrected. Controlled by input signal **m\_ttcn\_aeim\_berr[0]** generated by an optional external parity / ECC logic attached to the Message RAM.

0= No bit error detected when reading from Message RAM

1= Bit error detected and corrected (e.g. ECC)

**Bit 18 TOO:** Timeout Occurred

0= No timeout

1= Timeout reached

**Bit 17 UMD:** Unprocessed Message Discarded

When a new message is received while the acceptance filtering process for the previously received message has not yet completed, this message is discarded.

0= No unprocessed message discarded

1= Unprocessed message discarded

**Bit 16 TSW:** Timestamp Wraparound

0= No timestamp counter wrap-around

1= Timestamp counter wrapped around

**Bit 15 TEFL:** Tx Event FIFO Element Lost

0= No Tx Event FIFO element lost

1= Tx Event FIFO element lost, also set after write attempt to Tx Event FIFO of size zero

**Bit 14 TEFF:** Tx Event FIFO Full

0= Tx Event FIFO not full

1= Tx Event FIFO full

**Bit 13 TEFW:** Tx Event FIFO Watermark Reached

0= Tx Event FIFO fill level below watermark

1= Tx Event FIFO fill level reached watermark

**Bit 12 TEFN:** Tx Event FIFO New Entry

0= Tx Event FIFO unchanged

1= Tx Handler wrote Tx Event FIFO element

- Bit 11**      **TFE:**      Tx FIFO Empty  
0= Tx FIFO non-empty  
1= Tx FIFO empty
- Bit 10**      **TCF:**      Transmission Cancellation Finished  
0= No transmission cancellation finished  
1= Transmission cancellation finished
- Bit 9**        **TC:**        Transmission Completed  
0= No transmission completed  
1= Transmission completed
- Bit 8**        **HPM:**      High Priority Message  
0= No high priority message received  
1= High priority message received
- Bit 7**        **RF1L:**      Rx FIFO 1 Message Lost  
0= No Rx FIFO 1 message lost  
1= Rx FIFO 1 message lost, also set after write attempt to Rx FIFO 1 of size zero
- Bit 6**        **RF1F:**      Rx FIFO 1 Full  
0= Rx FIFO 1 not full  
1= Rx FIFO 1 full
- Bit 5**        **RF1W:**      Rx FIFO 1 Watermark Reached  
0= Rx FIFO 1 fill level below watermark  
1= Rx FIFO 1 fill level reached watermark
- Bit 4**        **RF1N:**      Rx FIFO 1 New Message  
0= No new message written to Rx FIFO 1  
1= New message written to Rx FIFO 1
- Bit 3**        **RF0L:**      Rx FIFO 0 Message Lost  
0= No Rx FIFO 0 message lost  
1= Rx FIFO 0 message lost, also set after write attempt to Rx FIFO 0 of size zero
- Bit 2**        **RF0F:**      Rx FIFO 0 Full  
0= Rx FIFO 0 not full  
1= Rx FIFO 0 full
- Bit 1**        **RF0W:**      Rx FIFO 0 Watermark Reached  
0= Rx FIFO 0 fill level below watermark  
1= Rx FIFO 0 fill level reached watermark
- Bit 0**        **RF0N:**      Rx FIFO 0 New Message  
0= No new message written to Rx FIFO 0  
1= New message written to Rx FIFO 0

### 2.3.15 Interrupt Enable (IE)

The settings in the Interrupt Enable register determine which status changes in the Interrupt Register will be signalled on an interrupt line.

0= Interrupt disabled

1= Interrupt enabled

Bits	31	30	29	28	27	26	25	24	23	22	21	20	19	18	17	16
0x54	STEE	FOEE	ACKEE	BEE	CRCEE	WDIE	BOE	EWE	EPE	ELOE	BEUE	BECE	res	TOOE	UMDE	TSWE
	RW-0	RW-0	RW-0	RW-0	RW-0	RW-0	RW-0	RW-0	RW-0	RW-0	RW-0	RW-0	R-0	RW-0	RW-0	RW-0
Bits	15	14	13	12	11	10	9	8	7	6	5	4	3	2	1	0
	TEFLE	TEFFE	TEFWE	TEFNE	TFEE	TCFE	TCE	HPME	RF1LE	RF1FE	RF1WE	RF1NE	RF0LE	RF0FE	RF0WE	RF0NE
	RW-0	RW-0	RW-0	RW-0	RW-0	RW-0	RW-0	RW-0	RW-0	RW-0	RW-0	RW-0	RW-0	RW-0	RW-0	RW-0

R = Read, W = Write; -n = value after reset

Table 16 Interrupt Enable (address 0x54)

<b>Bit 31</b>	<b>STEE:</b>	Stuff Error Interrupt Enable
<b>Bit 30</b>	<b>FOEE:</b>	Format Error Interrupt Enable
<b>Bit 29</b>	<b>ACKEE:</b>	Acknowledge Error Interrupt Enable
<b>Bit 28</b>	<b>BEE:</b>	Bit Error Interrupt Enable
<b>Bit 27</b>	<b>CRCEE:</b>	CRC Error Interrupt Enable
<b>Bit 26</b>	<b>WDIE:</b>	Watchdog Interrupt Enable
<b>Bit 25</b>	<b>BOE:</b>	Bus_Off Status Interrupt Enable
<b>Bit 24</b>	<b>EWE:</b>	Warning Status Interrupt Enable
<b>Bit 23</b>	<b>EPE:</b>	Error Passive Interrupt Enable
<b>Bit 22</b>	<b>ELOE:</b>	Error Logging Overflow Interrupt Enable
<b>Bit 21</b>	<b>BEUE:</b>	Bit Error Uncorrected Interrupt Enable
<b>Bit 20</b>	<b>BECE:</b>	Bit Error Corrected Interrupt Enable
<b>Bit 18</b>	<b>TOOE:</b>	Timeout Occurred Interrupt Enable
<b>Bit 17</b>	<b>UMDE:</b>	Unprocessed Message Discarded Interrupt Enable
<b>Bit 16</b>	<b>TSWE:</b>	Timestamp Wraparound Interrupt Enable
<b>Bit 15</b>	<b>TEFLE:</b>	Tx Event FIFO Event Lost Interrupt Enable
<b>Bit 14</b>	<b>TEFFE:</b>	Tx Event FIFO Full Interrupt Enable
<b>Bit 13</b>	<b>TEFWE:</b>	Tx Event FIFO Watermark Reached Interrupt Enable

---

<b>Bit 12</b>	<b>TEFNE:</b>	Tx Event FIDO New Entry Interrupt Enable
<b>Bit 11</b>	<b>TFEE:</b>	Tx FIFO Empty Interrupt Enable
<b>Bit 10</b>	<b>TCFE:</b>	Transmission Cancellation Finished Interrupt Enable
<b>Bit 9</b>	<b>TCE:</b>	Transmission Completed Interrupt Enable
<b>Bit 8</b>	<b>HPME:</b>	High Priority Message Interrupt Enable
<b>Bit 7</b>	<b>RF1LE:</b>	Rx FIFO 1 Message Lost Interrupt Enable
<b>Bit 6</b>	<b>RF1FE:</b>	Rx FIFO 1 Full Interrupt Enable
<b>Bit 5</b>	<b>RF1WE:</b>	Rx FIFO 1 Watermark Reached Interrupt Enable
<b>Bit 4</b>	<b>RF1NE:</b>	Rx FIFO 1 New Message Interrupt Enable
<b>Bit 3</b>	<b>RF0LE:</b>	Rx FIFO 0 Message Lost Interrupt Enable
<b>Bit 2</b>	<b>RF0FE:</b>	Rx FIFO 0 Full Interrupt Enable
<b>Bit 1</b>	<b>RF0WE:</b>	Rx FIFO 0 Watermark Reached Interrupt Enable
<b>Bit 0</b>	<b>RF0NE:</b>	Rx FIFO 0 New Message Interrupt Enable

### 2.3.16 Interrupt Line Select (ILS)

The Interrupt Line Select register assigns an interrupt generated by a specific interrupt flag from the Interrupt Register to one of the two module interrupt lines. For interrupt generation the respective interrupt line has to be enabled via **ILE.EINT0** and **ILE.EINT1**.

0= Interrupt assigned to interrupt line **m\_can\_int0**

1= Interrupt assigned to interrupt line **m\_can\_int1**

<b>Bits</b>	<b>31</b>	<b>30</b>	<b>29</b>	<b>28</b>	<b>27</b>	<b>26</b>	<b>25</b>	<b>24</b>	<b>23</b>	<b>22</b>	<b>21</b>	<b>20</b>	<b>19</b>	<b>18</b>	<b>17</b>	<b>16</b>
0x58	STEL	FOEL	ACKEL	BEL	CRCEL	WDIL	BOL	EWL	EPL	ELOL	BEUL	BECL	res	TOOL	UMDL	TSWL
	RW-0	RW-0	RW-0	RW-0	RW-0	RW-0	RW-0	RW-0	RW-0	RW-0	RW-0	RW-0	R-0	RW-0	RW-0	RW-0
<b>Bits</b>	<b>15</b>	<b>14</b>	<b>13</b>	<b>12</b>	<b>11</b>	<b>10</b>	<b>9</b>	<b>8</b>	<b>7</b>	<b>6</b>	<b>5</b>	<b>4</b>	<b>3</b>	<b>2</b>	<b>1</b>	<b>0</b>
	TEFLL	TEFFL	TEFWL	TEFNL	TFEL	TCFL	TCL	HPML	RF1LL	RF1FL	RF1WL	RF1NL	RF0LL	RF0FL	RF0WL	RF0NL
	RW-0	RW-0	RW-0	RW-0	RW-0	RW-0	RW-0	RW-0	RW-0	RW-0	RW-0	RW-0	RW-0	RW-0	RW-0	RW-0

R = Read, W = Write; -n = value after reset

**Table 17** Interrupt Line Select (address 0x58)

<b>Bit 31</b>	<b>STEL:</b>	Stuff Error Interrupt Line
<b>Bit 30</b>	<b>FOEL:</b>	Format Error Interrupt Line
<b>Bit 29</b>	<b>ACKEL:</b>	Acknowledge Error Interrupt Line
<b>Bit 28</b>	<b>BEL:</b>	Bit Error Interrupt Line
<b>Bit 27</b>	<b>CRCEL:</b>	CRC Error Interrupt Line
<b>Bit 26</b>	<b>WDIL:</b>	Watchdog Interrupt Line
<b>Bit 25</b>	<b>BOL:</b>	Bus_Off Status Interrupt Line
<b>Bit 24</b>	<b>EWL:</b>	Warning Status Interrupt Line
<b>Bit 23</b>	<b>EPL:</b>	Error Passive Interrupt Line
<b>Bit 22</b>	<b>ELOL:</b>	Error Logging Overflow Interrupt Line
<b>Bit 21</b>	<b>BEUL:</b>	Bit Error Uncorrected Interrupt Line
<b>Bit 20</b>	<b>BECL:</b>	Bit Error Corrected Interrupt Line
<b>Bit 18</b>	<b>TOOL:</b>	Timeout Occurred Interrupt Line
<b>Bit 17</b>	<b>UMDL:</b>	Unprocessed Message Discarded Interrupt Line
<b>Bit 16</b>	<b>TSWL:</b>	Timestamp Wraparound Interrupt Line
<b>Bit 15</b>	<b>TEFLL:</b>	Tx Event FIFO Event Lost Interrupt Line
<b>Bit 14</b>	<b>TEFFL:</b>	Tx Event FIFO Full Interrupt Line
<b>Bit 13</b>	<b>TEFWL:</b>	Tx Event FIFO Watermark Reached Interrupt Line

- Bit 12**      **TEFNL:** Tx Event FIFO New Entry Interrupt Line
- Bit 11**      **TFEL:** Tx FIFO Empty Interrupt Line
- Bit 10**      **TCFL:** Transmission Cancellation Finished Interrupt Line
- Bit 9**        **TCL:** Transmission Completed Interrupt Line
- Bit 8**        **HPML:** High Priority Message Interrupt Line
- Bit 7**        **RF1LL:** Rx FIFO 1 Message Lost Interrupt Line
- Bit 6**        **RF1FL:** Rx FIFO 1 Full Interrupt Line
- Bit 5**        **RF1WL:** Rx FIFO 1 Watermark Reached Interrupt Line
- Bit 4**        **RF1NL:** Rx FIFO 1 New Message Interrupt Line
- Bit 3**        **RF0LL:** Rx FIFO 0 Message Lost Interrupt Line
- Bit 2**        **RF0FL:** Rx FIFO 0 Full Interrupt Line
- Bit 1**        **RF0WL:** Rx FIFO 0 Watermark Reached Interrupt Line
- Bit 0**        **RF0NL:** Rx FIFO 0 New Message Interrupt Line

**2.3.17 Interrupt Line Enable (ILE)**

Each of the two interrupt lines to the CPU can be enabled / disabled separately by programming bits **EINT0** and **EINT1**.

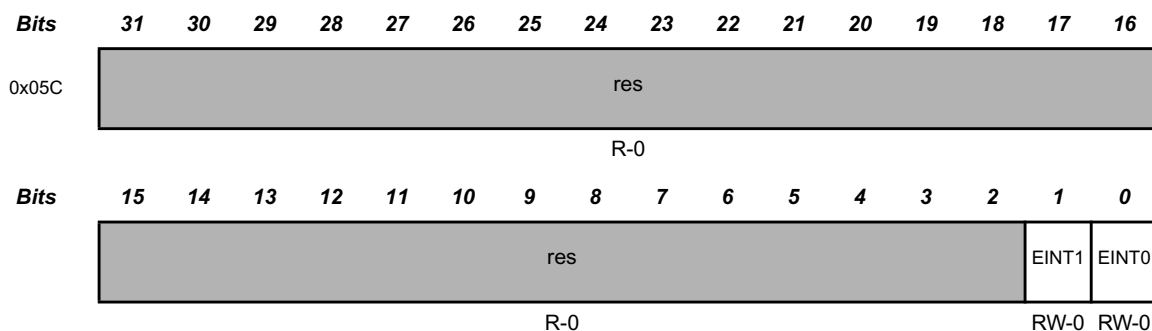

R = Read, W = Write; -n = value after reset

**Table 18**      *Interrupt Line Enable (address 0x05C)*

- Bit 1**            **EINT1:** Enable Interrupt Line 1  
 0= Interrupt line **m\_ttcant\_int1** disabled  
 1= Interrupt line **m\_ttcant\_int1** enabled
- Bit 0**            **EINT0:** Enable Interrupt Line 0  
 0= Interrupt line **m\_ttcant\_int0** disabled  
 1= Interrupt line **m\_ttcant\_int0** enabled

### 2.3.18 Global Filter Configuration (GFC)

Global settings for Message ID filtering. The Global Filter Configuration controls the filter path for standard and extended messages as described in Figure 5 and Figure 6.

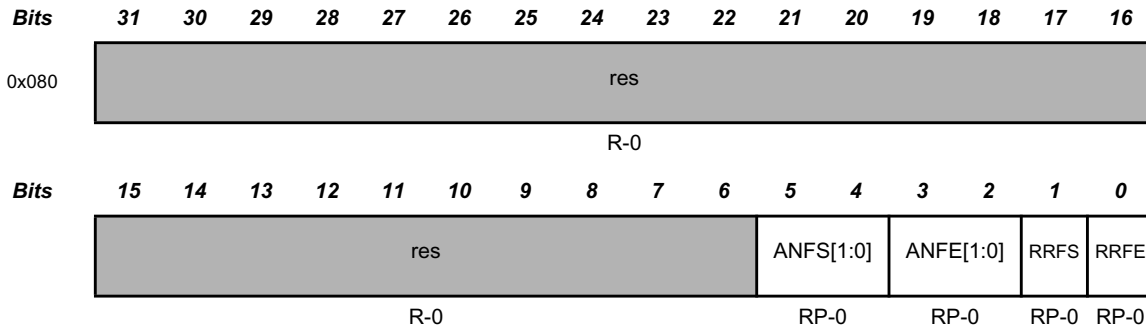

R = Read, P = Protected write; -n = value after reset

Table 19 Global Filter Configuration (address 0x080)

#### Bit 5:4 ANFS[1:0]: Accept Non-matching Frames Standard

Defines how received messages with 11-bit IDs that do not match any element of the filter list are treated.

00= Accept in Rx FIFO 0

01= Accept in Rx FIFO 1

10= Reject

11= Reject

#### Bit 3:2 ANFE[1:0]: Accept Non-matching Frames Extended

Defines how received messages with 29-bit IDs that do not match any element of the filter list are treated.

00= Accept in Rx FIFO 0

01= Accept in Rx FIFO 1

10= Reject

11= Reject

#### Bit 1 RRFS: Reject Remote Frames Standard

0= Filter remote frames with 11-bit standard IDs

1= Reject all remote frames with 11-bit standard IDs

#### Bit 0 RRFE: Reject Remote Frames Extended

0= Filter remote frames with 29-bit extended IDs

1= Reject all remote frames with 29-bit extended IDs

**2.3.19 Standard ID Filter Configuration (SIDFC)**

Settings for 11-bit standard Message ID filtering.

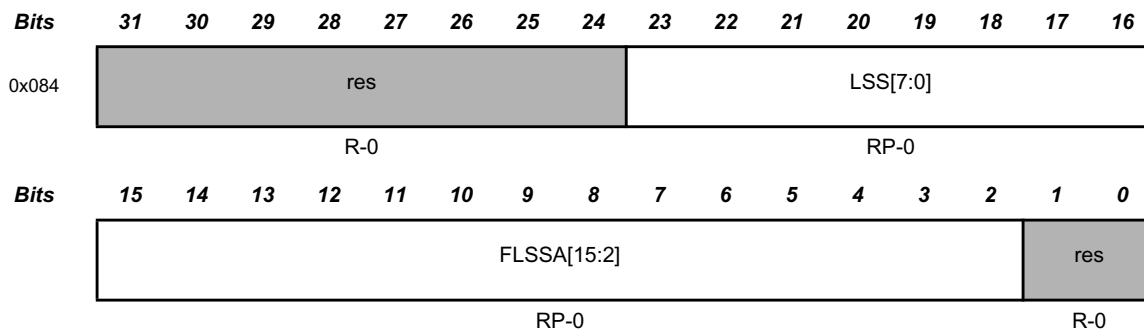

R = Read, P = Protected write; -n = value after reset

**Table 20** Standard ID Filter Configuration (address 0x084)

**Bit 23:16 LSS[7:0]:** List Size Standard

- 0= No standard Message ID filter
- 1-128= Number of standard Message ID filter elements
- >128= Values greater than 128 are interpreted as 128

**Bit 15:2 FLSSA[15:2]:** Filter List Standard Start Address

Start address of standard Message ID filter list (32-bit word address, see Figure 2).

**2.3.20 Extended ID Filter Configuration (XIDFC)**

Settings for 29-bit extended Message ID filtering.

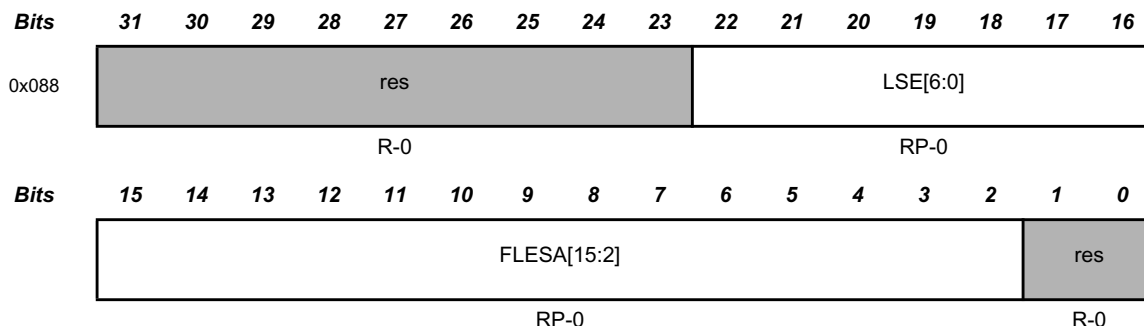

R = Read, P = Protected write; -n = value after reset

**Table 21** Extended ID Filter Configuration (address 0x088)

**Bit 22:16 LSE[6:0]:** List Size Extended

- 0= No extended Message ID filter
- 1-64= Number of extended Message ID filter elements
- >64= Values greater than 64 are interpreted as 64

**Bit 15:2 FLESA[15:2]:** Filter List Extended Start Address

Start address of extended Message ID filter list (32-bit word address, see Figure 2).

**2.3.21 Extended ID AND Mask (XIDAM)**

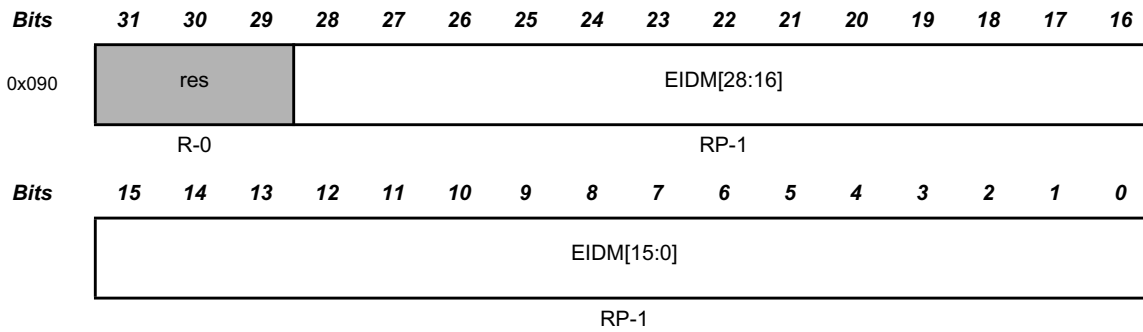

R = Read, P = Protected write; -n = value after reset

Table 22 Extended ID AND Mask (address 0x090)

**Bit 28:0 EIDM[28:0]:** Extended ID Mask

For acceptance filtering of extended frames the Extended ID AND Mask is ANDed with the Message ID of a received frame. Intended for masking of 29-bit IDs in SAE J1939. With the reset value of all bits set to one the mask is not active.

**2.3.22 High Priority Message Status (HPMS)**

This register is updated every time a Message ID filter element configured to generate a priority event matches. This can be used to monitor the status of incoming high priority messages and to enable fast access to these messages.

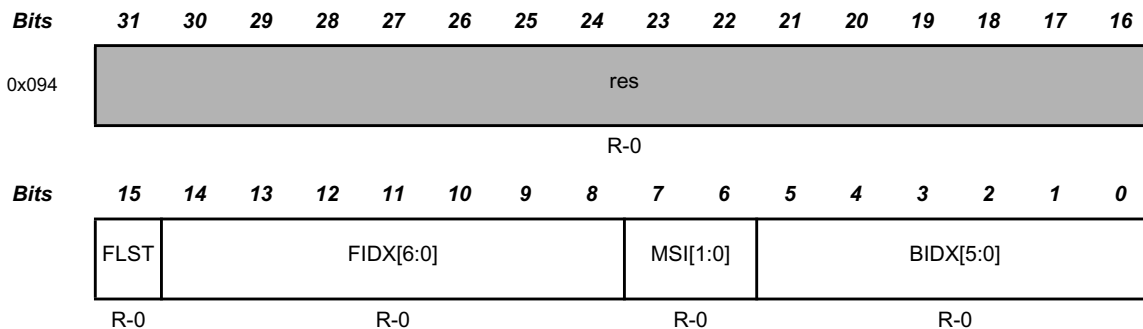

R = Read; -n = Value after reset

Table 23 High Priority Message Status (address 0x094)

**Bit 15 FLST:** Filter List

Indicates the filter list of the matching filter element.  
 0= Standard Filter List  
 1= Extended Filter List

**Bit 14:8 FIDX[6:0]:** Filter Index

Index of matching filter element. Range is 0 to **SIDFC.LSS** - 1 resp. **XIDFC.LSE** - 1.

**Bit 7:6 MSI[1:0]:** Message Storage Indicator

00= No FIFO selected  
 01= FIFO overrun  
 10= Message stored in FIFO 0  
 11= Message stored in FIFO 1

**Bit 5:0 BIDX[5:0]:** Buffer Index

Index of Rx FIFO element to which the message was stored. Only valid when **MSI[1]** = '1'.

### 2.3.23 Rx FIFO 0 Configuration (RXF0C)

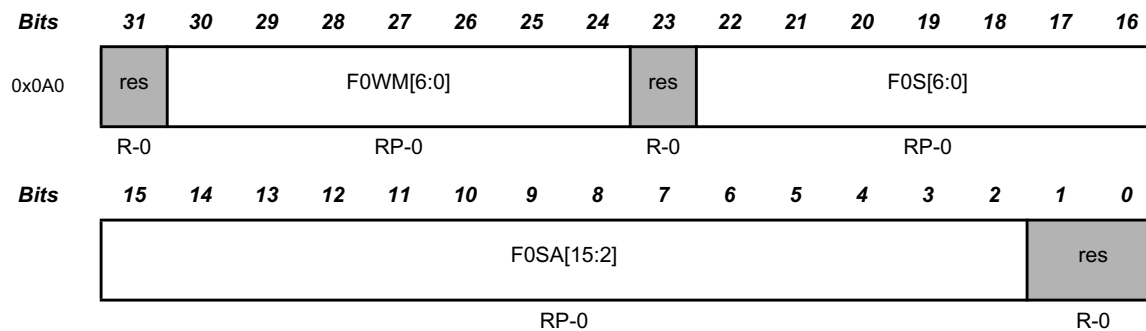

R = Read, P = Protected write; -n = Value after reset

Table 24 Rx FIFO 0 Configuration (address 0x0A0)

- Bit 30:24 F0WM[6:0]:** Rx FIFO 0 Watermark  
 0= Watermark interrupt disabled  
 1-64= Level for Rx FIFO 0 watermark interrupt (**IR.RF0W**)  
 >64= Watermark interrupt disabled
- Bit 22:16 F0S[6:0]:** Rx FIFO 0 Size  
 0= No Rx FIFO 0  
 1-64= Number of Rx FIFO 0 elements  
 >64= Values greater than 64 are interpreted as 64  
 The Rx FIFO 0 elements are indexed from 0 to **F0S**-1
- Bit 15:2 F0SA[15:2]:** Rx FIFO 0 Start Address  
 Start address of Rx FIFO 0 in Message RAM (32-bit word address, see Figure 2).

### 2.3.24 Rx FIFO 0 Status (RXF0S)

The register is reset to zero when **CCCR.INIT** is set to '1'.

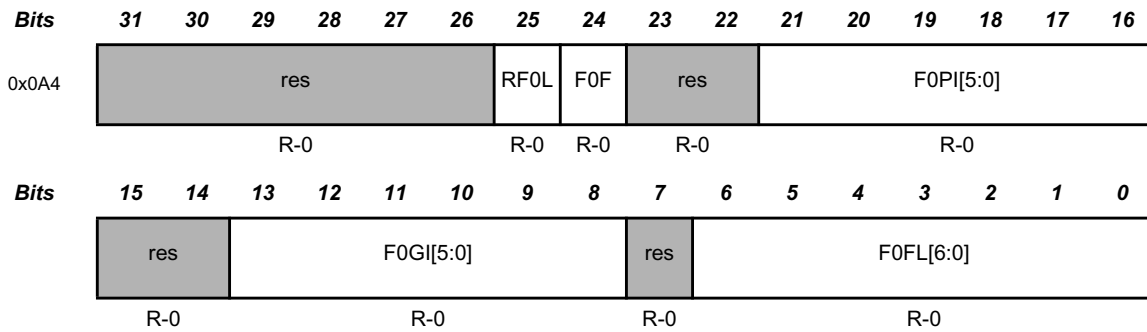

R = Read; -n = value after reset

Table 25 Rx FIFO 0 Status (address 0x0A4)

**Bit 25 RF0L:** Rx FIFO 0 Message Lost

This bit is a copy of interrupt flag **IR.RF0L**. When **IR.RF0L** is reset, this bit is also reset.

0= No Rx FIFO 0 message lost

1= Rx FIFO 0 message lost, also set after write attempt to Rx FIFO 0 of size zero

**Bit 24 F0F:** Rx FIFO 0 Full

0= Rx FIFO 0 not full

1= Rx FIFO 0 full

**Bit 21:16 F0PI[5:0]:** Rx FIFO 0 Put Index

Rx FIFO 0 write index pointer, range 0 to 63. For internal use only.

**Bit 13:8 F0GI[5:0]:** Rx FIFO 0 Get Index

Rx FIFO 0 read index pointer, range 0 to 63.

**Bit 6:0 F0FL[6:0]:** Rx FIFO 0 Fill Level

Number of elements stored in Rx FIFO 0, range 0 to 64.

### 2.3.25 Rx FIFO 0 Acknowledge (RXF0A)

The register is reset to zero when **CCCR.INIT** is set to '1'.

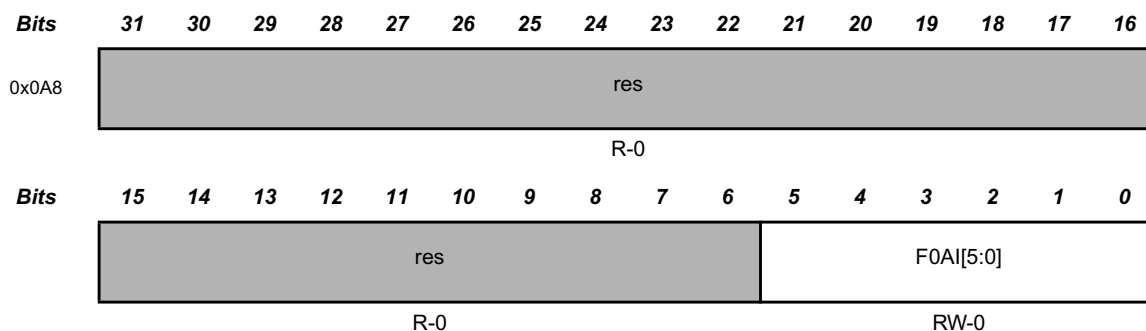

R = Read, W = Write; -n = value after reset

Table 26 Rx FIFO 0 Acknowledge (address 0x0A8)

#### Bit 5:0 F0AI[5:0]: Rx FIFO 0 Acknowledge Index

After the Host has read a message or a sequence of messages from Rx FIFO 0 it has to write the buffer index of the last element read from Rx FIFO 0 to **F0AI**. This will set the Rx FIFO 0 Get Index **RXF0S.F0GI** to **F0AI + 1** and update the FIFO 0 Fill Level **RXF0S.F0FL**.

### 2.3.26 Rx FIFO 1 Configuration (RXF1C)

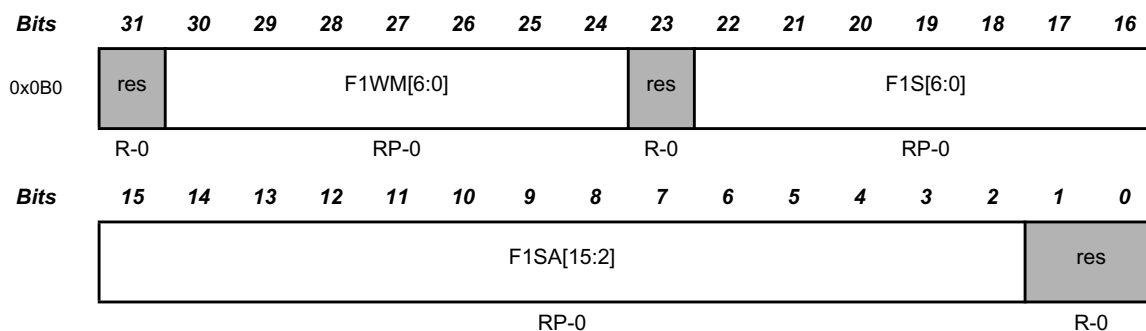

R = Read, P = Protected write; -n = value after reset

Table 27 Rx FIFO 1 Configuration (address 0x0B0)

#### Bit 30:24 F1WM[6:0]: Rx FIFO 1 Watermark

- 0= Watermark interrupt disabled
- 1-64= Level for Rx FIFO 1 watermark interrupt (**IR.RF1W**)
- >64= Watermark interrupt disabled

#### Bit 22:16 F1S[6:0]: Rx FIFO 1 Size

- 0= No Rx FIFO 1
  - 1-64= Number of Rx FIFO 1 elements
  - >64= Values greater than 64 are interpreted as 64
- The Rx FIFO 1 elements are indexed from 0 to **F1S - 1**

#### Bit 15:2 F1SA[15:2]: Rx FIFO 1 Start Address

Start address of Rx FIFO 1 in Message RAM (32-bit word address, see Figure 2).

### 2.3.27 Rx FIFO 1 Status (RXF1S)

The register is reset to zero when **CCCR.INIT** is set to '1'.

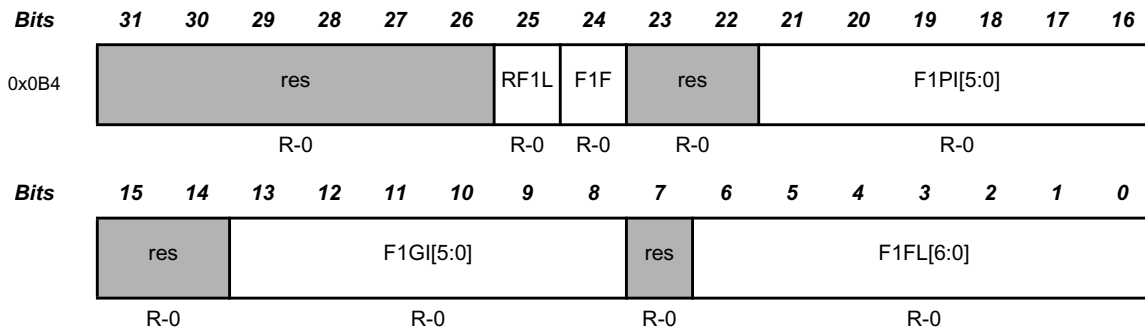

R = Read; -n = value after reset

Table 28 Rx FIFO 1 Status (address 0x0B4)

**Bit 25 RF1L:** Rx FIFO 1 Message Lost

This bit is a copy of interrupt flag **IR.RF1L**. When **IR.RF1L** is reset, this bit is also reset.

0= No Rx FIFO 1 message lost

1= Rx FIFO 1 message lost, also set after write attempt to Rx FIFO 1 of size zero

**Bit 24 F1F:** Rx FIFO 1 Full

0= Rx FIFO 1 not full

1= Rx FIFO 1 full

**Bit 21:16 F1PI[5:0]:** Rx FIFO 1 Put Index

Rx FIFO 1 write index pointer, range 0 to 63. For internal use only.

**Bit 13:8 F1GI[5:0]:** Rx FIFO 1 Get Index

Rx FIFO 1 read index pointer, range 0 to 63.

**Bit 6:0 F1FL[6:0]:** Rx FIFO 1 Fill Level

Number of elements stored in Rx FIFO 1, range 0 to 64.

### 2.3.28 Rx FIFO 1 Acknowledge (RXF1A)

The register is reset to zero when **CCCR.INIT** is set to '1'.

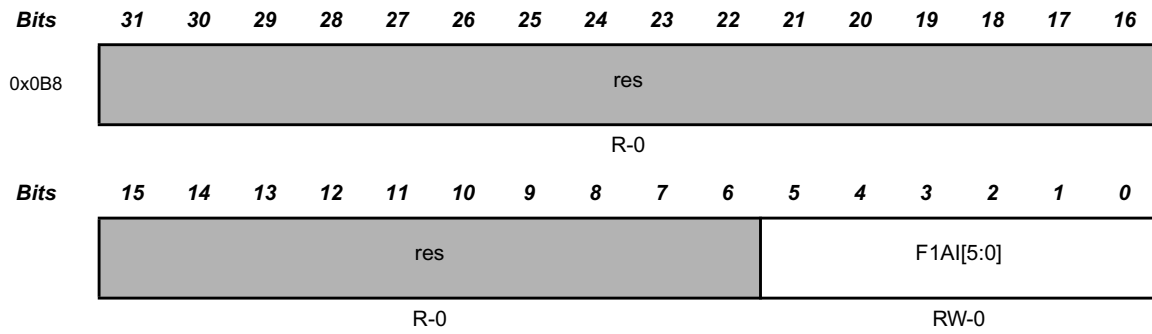

R = Read, W = Write; -n = value after reset

Table 29 Rx FIFO 1 Acknowledge (address 0x0B8)

#### Bit 5:0 F1AI[5:0]: Rx FIFO 1 Acknowledge Index

After the Host has read a message or a sequence of messages from Rx FIFO 1 it has to write the buffer index of the last element read from Rx FIFO 1 to **F1AI**. This will set the Rx FIFO 1 Get Index **RXF1S.F1GI** to **F1AI + 1** and update the FIFO 1 Fill Level **RXF1S.F1FL**.

### 2.3.29 Tx Buffer Configuration (TXBC)

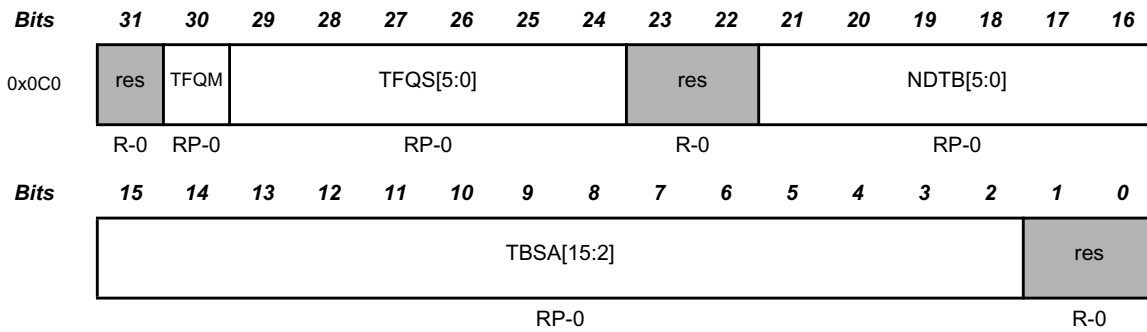

R = Read, P = Protected write; -n = value after reset

Table 30 Tx Buffer Configuration (address 0x0C0)

**Bit 30 TFQM:** Tx FIFO/Queue Mode

0= Tx FIFO operation

1= Tx Queue operation

**Bit 29:24 TFQS[5:0]:** Transmit FIFO/Queue Size

0= No Tx FIFO/Queue

1-32= Number of Tx Buffers used for Tx FIFO/Queue

>32= Values greater than 32 are interpreted as 32

**Bit 21:16 NDTB[5:0]:** Number of Dedicated Transmit Buffers

0= No Dedicated Tx Buffers

1-32= Number of Dedicated Tx Buffers

>32= Values greater than 32 are interpreted as 32

**Bit 15:2 TBSA[15:2]:** Tx Buffers Start Address

Start address of Tx Buffers section in Message RAM (32-bit word address, see Figure 2).

**Note:** Be aware that the sum of TFQS and NDTB may be not greater than 32. There is no check for erroneous configurations. The Tx Buffers section in the Message RAM starts with the dedicated Tx Buffers.

### 2.3.30 Tx FIFO/Queue Status (TXFQS)

The Tx FIFO/Queue status is related to the pending Tx requests listed in register **TXBRP**. Therefore the effect of Add/Cancellation requests may be delayed due to a running Tx scan (**TXBRP** not yet updated).

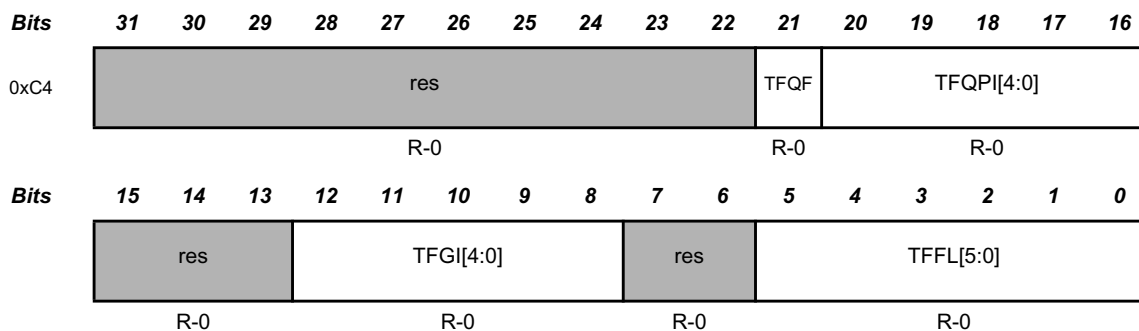

R = Read; -n = value after reset

Table 31 Tx FIFO/Queue Status (address 0xC4)

**Bit 21 TFQF:** Tx FIFO/Queue Full

0= Tx FIFO/Queue not full

1= Tx FIFO/Queue full

**Bit 20:16 TFQPI[4:0]:** Tx FIFO/Queue Put Index

Tx FIFO/Queue write index pointer, range 0 to 31.

**Bit 12:8 TFGI[4:0]:** Tx FIFO Get Index

Tx FIFO read index pointer, range 0 to 31. For internal use only. Read as zero when Tx Queue operation is configured (**TXBC.TFQM** = '1').

**Bit 5:0 TFFL[5:0]:** Tx FIFO Free Level

Number of consecutive free Tx FIFO elements starting from **TFGI**, range 0 to 32. Read as zero when Tx Queue operation is configured (**TXBC.TFQM** = '1')

**Note:** In case of mixed configurations where dedicated Tx Buffers are combined with a Tx FIFO or a Tx Queue, the Put and Get Indices indicate the number of the Tx Buffer starting with the first dedicated Tx Buffers.

**Example:** For a configuration of 12 dedicated Tx Buffers and a Tx FIFO of 20 Buffers a Put Index of 15 points to the fourth buffer of the Tx FIFO.

### 2.3.31 Tx Buffer Request Pending (TXBRP)

Bits	31	30	29	28	27	26	25	24	23	22	21	20	19	18	17	16
0x0CC	TRP31	TRP30	TRP29	TRP28	TRP27	TRP26	TRP25	TRP24	TRP23	TRP22	TRP21	TRP20	TRP19	TRP18	TRP17	TRP16
	R-0	R-0	R-0	R-0	R-0	R-0	R-0	R-0	R-0	R-0	R-0	R-0	R-0	R-0	R-0	R-0

Bits	15	14	13	12	11	10	9	8	7	6	5	4	3	2	1	0
	TRP15	TRP14	TRP13	TRP12	TRP11	TRP10	TRP9	TRP8	TRP7	TRP6	TRP5	TRP4	TRP3	TRP2	TRP1	TRP0
	R-0	R-0	R-0	R-0	R-0	R-0	R-0	R-0	R-0	R-0	R-0	R-0	R-0	R-0	R-0	R-0

R = Read; -n = value after reset

Table 32 Tx Buffer Request Pending (address 0x0CC)

#### Bit 31:0 TRP[31:0]: Transmission Request Pending

Each Tx Buffer has its own Transmission Request Pending bit. The bits are set via register **TXBAR**. The bits are reset after a requested transmission has completed or has been cancelled via register **TXBCR**.

**TXBRP** bits are set only for those Tx Buffers configured via **TXBC**. After a **TXBRP** bit has been set, a Tx scan (see Section 3.5, *Tx Handling*) is started to check for the pending Tx request with the highest priority (Tx Buffer with lowest Message ID).

A cancellation request resets the corresponding transmission request pending bit of register **TXBRP**. In case a transmission has already been started when a cancellation is requested, this is done at the end of the transmission, regardless whether the transmission was successful or not. The cancellation request bits are reset directly after the corresponding **TXBRP** bit has been reset.

After a cancellation has been requested, a finished cancellation is signalled via **TXBCF**

- after successful transmission together with the corresponding **TXBTO** bit
- when the transmission has not yet been started at the point of cancellation
- when the transmission has been aborted due to lost arbitration
- when an error occurred during frame transmission

In DAR mode all transmissions are automatically cancelled if they are not successful. The corresponding **TXBCF** bit is set for all unsuccessful transmissions.

0= No transmission request pending

1= Transmission request pending

**Note:** *TXBRP bits which are set while a Tx scan is in progress are not considered during this particular Tx scan. In case a cancellation is requested for such a Tx Buffer, this Add Request is cancelled immediately, the corresponding TXBRP bit is reset.*

### 2.3.32 Tx Buffer Add Request (TXBAR)

Bits	31	30	29	28	27	26	25	24	23	22	21	20	19	18	17	16
0x0D0	AR31	AR30	AR29	AR28	AR27	AR26	AR25	AR24	AR23	AR22	AR21	AR20	AR19	AR18	AR17	AR16
	RW-0	RW-0	RW-0	RW-0	RW-0	RW-0	RW-0	RW-0	RW-0	RW-0	RW-0	RW-0	RW-0	RW-0	RW-0	RW-0

Bits	15	14	13	12	11	10	9	8	7	6	5	4	3	2	1	0
	AR15	AR14	AR13	AR12	AR11	AR10	AR9	AR8	AR7	AR6	AR5	AR4	AR3	AR2	AR1	AR0
	RW-0	RW-0	RW-0	RW-0	RW-0	RW-0	RW-0	RW-0	RW-0	RW-0	RW-0	RW-0	RW-0	RW-0	RW-0	RW-0

R = Read, W = Write; -n = value after reset

Table 33 Tx Buffer Add Request (address 0x0D0)

#### Bit 31:0 AR[31:0]: Add Request

Each Tx Buffer has its own Add Request bit. Writing a '1' will set the corresponding Add Request bit; writing a '0' has no impact. This enables the Host to set transmission requests for multiple Tx Buffers with one write to **TXBAR**. **TXBAR** bits are set only for those Tx Buffers configured via **TXBC**. When no Tx scan is running, the bits are reset immediately, else the bits remain set until the Tx scan process has completed.

0= No transmission request added

1= Transmission requested added

**Note: If an add request is applied for a Tx Buffer with pending transmission request (corresponding TXBRP bit already set), this add request is ignored.**

### 2.3.33 Tx Buffer Cancellation Request (TXBCR)

Bits	31	30	29	28	27	26	25	24	23	22	21	20	19	18	17	16
0x0D4	CR31	CR30	CR29	CR28	CR27	CR26	CR25	CR24	CR23	CR22	CR21	CR20	CR19	CR18	CR17	CR16
	RW-0	RW-0	RW-0	RW-0	RW-0	RW-0	RW-0	RW-0	RW-0	RW-0	RW-0	RW-0	RW-0	RW-0	RW-0	RW-0

Bits	15	14	13	12	11	10	9	8	7	6	5	4	3	2	1	0
	CR15	CR14	CR13	CR12	CR11	CR10	CR9	CR8	CR7	CR6	CR5	CR4	CR3	CR2	CR1	CR0
	RW-0	RW-0	RW-0	RW-0	RW-0	RW-0	RW-0	RW-0	RW-0	RW-0	RW-0	RW-0	RW-0	RW-0	RW-0	RW-0

R = Read, W = Write; -n = value after reset

Table 34 Tx Buffer Cancellation Request (address 0x0D4)

#### Bit 31:0 CR[31:0]: Cancellation Request

Each Tx Buffer has its own Cancellation Request bit. Writing a '1' will set the corresponding Cancellation Request bit; writing a '0' has no impact. This enables the Host to set cancellation requests for multiple Tx Buffers with one write to **TXBCR**. **TXBCR** bits are set only for those Tx Buffers configured via **TXBC**. The bits remain set until the corresponding bit of **TXBRP** is reset.

0= No cancellation pending

1= Cancellation pending

**2.3.34 Tx Buffer Transmission Occurred (TXBTO)**

Bits	31	30	29	28	27	26	25	24	23	22	21	20	19	18	17	16
0x0D8	TO31	TO30	TO29	TO28	TO27	TO26	TO25	TO24	TO23	TO22	TO21	TO20	TO19	TO18	TO17	TO16
	R-0	R-0	R-0	R-0	R-0	R-0	R-0	R-0	R-0	R-0	R-0	R-0	R-0	R-0	R-0	R-0

Bits	15	14	13	12	11	10	9	8	7	6	5	4	3	2	1	0
	TO15	TO14	TO13	TO12	TO11	TO10	TO9	TO8	TO7	TO6	TO5	TO4	TO3	TO2	TO1	TO0
	R-0	R-0	R-0	R-0	R-0	R-0	R-0	R-0	R-0	R-0	R-0	R-0	R-0	R-0	R-0	R-0

R = Read; -n = value after reset

**Table 35** Tx Buffer Transmission Occurred (address 0x0D8)**Bit 31:0 TO[31:0]:** Transmission Occurred

Each Tx Buffer has its own Transmission Occurred bit. The bits are set when the corresponding **TXBRP** bit is cleared after a successful transmission. The bits are reset when a new transmission is requested by writing a '1' to the corresponding bit of register **TXBAR**.

0= No transmission occurred

1= Transmission occurred

**2.3.35 Tx Buffer Cancellation Finished (TXBCF)**

Bits	31	30	29	28	27	26	25	24	23	22	21	20	19	18	17	16
0x0DC	CF31	CF30	CF29	CF28	CF27	CF26	CF25	CF24	CF23	CF22	CF21	CF20	CF19	CF18	CF17	CF16
	R-0	R-0	R-0	R-0	R-0	R-0	R-0	R-0	R-0	R-0	R-0	R-0	R-0	R-0	R-0	R-0

Bits	15	14	13	12	11	10	9	8	7	6	5	4	3	2	1	0
	CF15	CF14	CF13	CF12	CF11	CF10	CF9	CF8	CF7	CF6	CF5	CF4	CF3	CF2	CF1	CF0
	R-0	R-0	R-0	R-0	R-0	R-0	R-0	R-0	R-0	R-0	R-0	R-0	R-0	R-0	R-0	R-0

R = Read; -n = value after reset

**Table 36** Transmit Buffer Cancellation Finished (address 0x0DC)**Bit 31:0 CF[31:0]:** Cancellation Finished

Each Tx Buffer has its own Cancellation Finished bit. The bits are set when the corresponding **TXBRP** bit is cleared after a cancellation was requested via **TXBCR**. In case the corresponding **TXBRP** bit was not set at the point of cancellation, **CF** is set immediately. The bits are reset when a new transmission is requested by writing a '1' to the corresponding bit of register **TXBAR**.

0= No transmit buffer cancellation

1= Transmit buffer cancellation finished

**2.3.36 Tx Buffer Transmission Interrupt Enable (TXBTIE)**

<b>Bits</b>	<b>31</b>	<b>30</b>	<b>29</b>	<b>28</b>	<b>27</b>	<b>26</b>	<b>25</b>	<b>24</b>	<b>23</b>	<b>22</b>	<b>21</b>	<b>20</b>	<b>19</b>	<b>18</b>	<b>17</b>	<b>16</b>
0x0E0	TIE31	TIE30	TIE29	TIE28	TIE27	TIE26	TIE25	TIE24	TIE23	TIE22	TIE21	TIE20	TIE19	TIE18	TIE17	TIE16
	RW-0	RW-0	RW-0	RW-0	RW-0	RW-0	RW-0	RW-0	RW-0	RW-0	RW-0	RW-0	RW-0	RW-0	RW-0	RW-0
<b>Bits</b>	<b>15</b>	<b>14</b>	<b>13</b>	<b>12</b>	<b>11</b>	<b>10</b>	<b>9</b>	<b>8</b>	<b>7</b>	<b>6</b>	<b>5</b>	<b>4</b>	<b>3</b>	<b>2</b>	<b>1</b>	<b>0</b>
	TIE15	TIE14	TIE13	TIE12	TIE11	TIE10	TIE9	TIE8	TIE7	TIE6	TIE5	TIE4	TIE3	TIE2	TIE1	TIE0
	RW-0	RW-0	RW-0	RW-0	RW-0	RW-0	RW-0	RW-0	RW-0	RW-0	RW-0	RW-0	RW-0	RW-0	RW-0	RW-0

R = Read, W = Write; -n = value after reset

**Table 37 Tx Buffer Transmission Interrupt Enable (address 0x0E0)**

**Bit 31:0 TIE[31:0]:** Transmission Interrupt Enable

Each Tx Buffer has its own Transmission Interrupt Enable bit.

0= Transmission interrupt disabled

1= Transmission interrupt enable

**2.3.37 Tx Buffer Cancellation Finished Interrupt Enable (TXBCIE)**

<b>Bits</b>	<b>31</b>	<b>30</b>	<b>29</b>	<b>28</b>	<b>27</b>	<b>26</b>	<b>25</b>	<b>24</b>	<b>23</b>	<b>22</b>	<b>21</b>	<b>20</b>	<b>19</b>	<b>18</b>	<b>17</b>	<b>16</b>
0x0E4	CFIE31	CFIE30	CFIE29	CFIE28	CFIE27	CFIE26	CFIE25	CFIE24	CFIE23	CFIE22	CFIE21	CFIE20	CFIE19	CFIE18	CFIE17	CFIE16
	RW-0	RW-0	RW-0	RW-0	RW-0	RW-0	RW-0	RW-0	RW-0	RW-0	RW-0	RW-0	RW-0	RW-0	RW-0	RW-0
<b>Bits</b>	<b>15</b>	<b>14</b>	<b>13</b>	<b>12</b>	<b>11</b>	<b>10</b>	<b>9</b>	<b>8</b>	<b>7</b>	<b>6</b>	<b>5</b>	<b>4</b>	<b>3</b>	<b>2</b>	<b>1</b>	<b>0</b>
	CFIE15	CFIE14	CFIE13	CFIE12	CFIE11	CFIE10	CFIE9	CFIE8	CFIE7	CFIE6	CFIE5	CFIE4	CFIE3	CFIE2	CFIE1	CFIE0
	RW-0	RW-0	RW-0	RW-0	RW-0	RW-0	RW-0	RW-0	RW-0	RW-0	RW-0	RW-0	RW-0	RW-0	RW-0	RW-0

R = Read, W = Write; -n = value after reset

**Table 38 Tx Buffer Cancellation Finished Interrupt Enable (address 0x0E4)**

**Bit 31:0 CFIE[31:0]:** Cancellation Finished Interrupt Enable

Each Tx Buffer has its own Cancellation Finished Interrupt Enable bit.

0= Cancellation finished interrupt disabled

1= Cancellation finished interrupt enabled

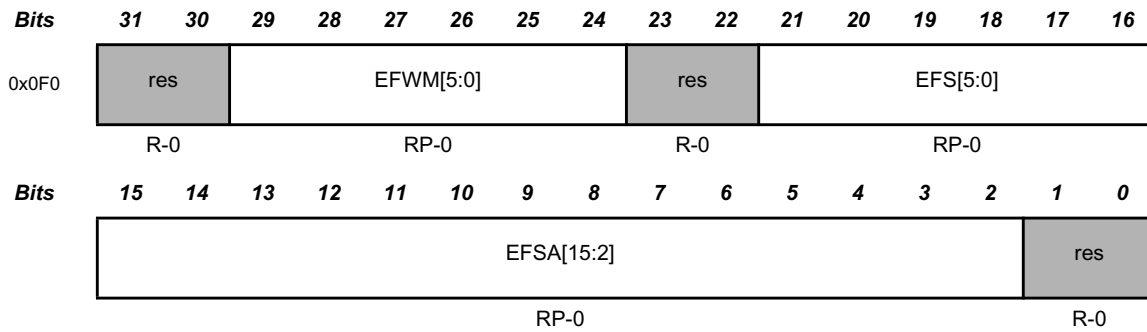
**2.3.38 Tx Event FIFO Configuration (TXEFC)**

R = Read, P = Protected write; -n = value after reset

**Table 39** Tx Event FIFO Configuration (address 0x0F0)

**Bit 29:24 EFWM[5:0]:** Event FIFO Watermark

- 0= Watermark interrupt disabled
- 1-32= Level for Tx Event FIFO watermark interrupt (**IR.TEFW**)
- >32= Watermark interrupt disabled

**Bit 21:16 EFS[5:0]:** Event FIFO Size

- 0= Tx Event FIFO disabled
  - 1-32= Number of Tx Event FIFO elements
  - >32= Values greater than 32 are interpreted as 32
- The Tx Event FIFO elements are indexed from 0 to **EFS-1**

**Bit 15:2 EFSA[15:2]:** Event FIFO Start Address

Start address of Tx Event FIFO in Message RAM (32-bit word address, see Figure 2).

**2.3.39 Tx Event FIFO Status (TXEFS)**

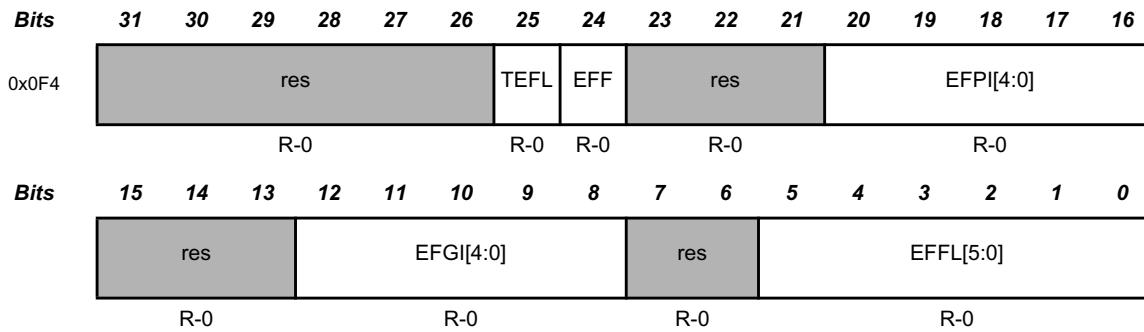

R = Read; -n = value after reset

**Table 40 Tx Event FIFO Status (address 0x0F4)**

- Bit 25 TEFL:** Tx Event FIFO Element Lost  
 This bit is a copy of interrupt flag **IR.TEFL**. When **IR.TEFL** is reset, this bit is also reset.  
 0= No Tx Event FIFO element lost  
 1= Tx Event FIFO element lost, also set after write attempt to Tx Event FIFO of size zero.
- Bit 24 EFF:** Event FIFO Full  
 0= Tx Event FIFO not full  
 1= Tx Event FIFO full
- Bit 20:16 EFPI[4:0]:** Event FIFO Put Index  
 Tx Event FIFO write index pointer, range 0 to 31. For internal use only.
- Bit 12:8 EFGI[4:0]:** Event FIFO Get Index  
 Tx Event FIFO read index pointer, range 0 to 31.
- Bit 5:0 EFFL[5:0]:** Event FIFO Fill Level  
 Number of elements stored in Tx Event FIFO, range 0 to 32.

**2.3.40 Tx Event FIFO Acknowledge (TXEFA)**

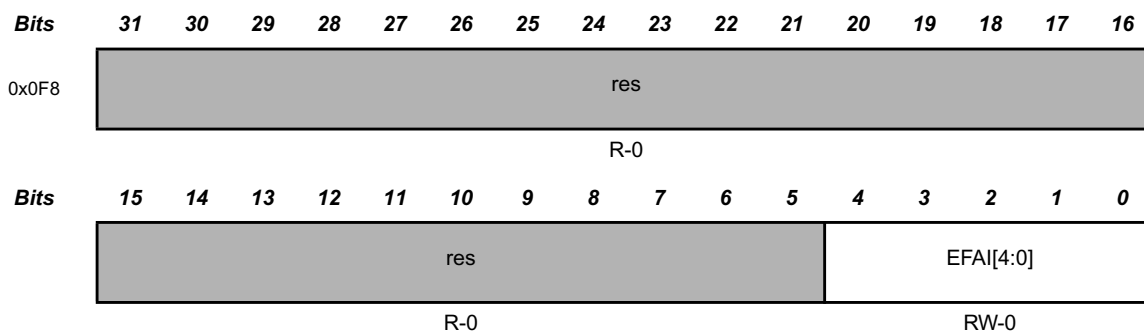

R = Read, W = Write; -n = value after reset

**Table 41 Tx Event FIFO Acknowledge (address 0x0F8)**

- Bit 4:0 EFAI[4:0]:** Event FIFO Acknowledge Index  
 After the Host has read an element or a sequence of elements from the Tx Event FIFO it has to write the index of the last element read from Tx Event FIFO to **EFAI**. This will set the Tx Event FIFO Get Index **TXEFS.EFGI** to **EFAI + 1** and update the FIFO 0 Fill Level **TXEFS.EFFL**.

### 2.3.41 TT Trigger Memory Configuration (TTTMC)

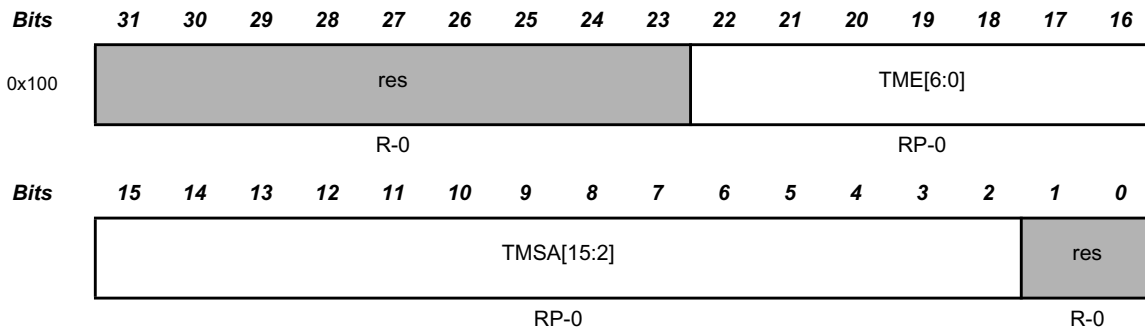

R = Read, P = Protected write; -n = value after reset

Table 42 TT Trigger Memory Configuration (address 0x100)

**Bit 22:16 TME[6:0]:** Trigger Memory Elements

0= No Trigger Memory

1-64= Number of Trigger Memory elements

>64= Values greater than 64 are interpreted as 64

**Bit 15:2 TMSA[15:2]:** Trigger Memory Start Address

Start address of Trigger Memory in Message RAM (32-bit word address, see Figure 2).

### 2.3.42 TT Reference Message Configuration (TTRMC)

For details about handling of reference messages see Section 4.7.1.

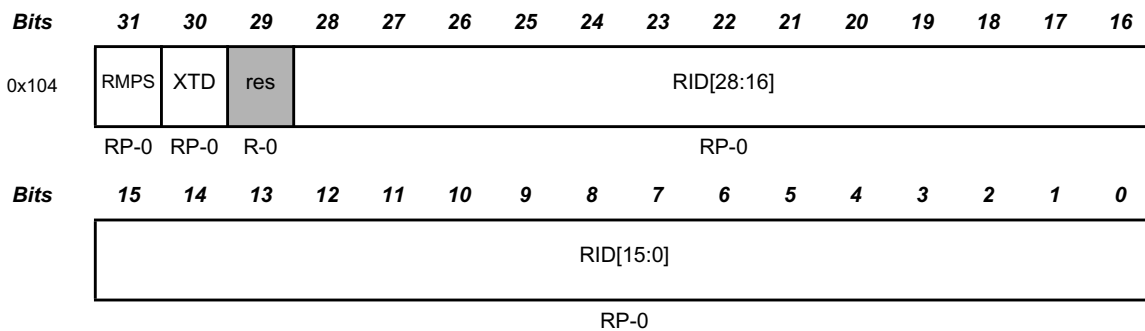

R = Read, P = Protected write; -n = value after reset

Table 43 TT Reference Message Configuration (address 0x104)

**Bit 31 RMPS:** Reference Message Payload Select

Ignored in case of time slaves.

0= Reference message has no additional payload

1= The following elements are taken from Tx Buffer 0:  
 Message Marker **MM**, Event FIFO Control **EFC**, Data Length Code **DLC**, Data Bytes **DB**  
 (Level 1: bytes 2-8, Level 0,2: bytes 5-8)

**Bit 30 XTD:** Extended Identifier

0= 11-bit standard identifier

1= 29-bit extended identifier

**Bit 28:0 RID[28:0]:** Reference Identifier

Identifier transmitted with reference message and used for reference message filtering. Standard or extended reference identifier depending on bit **XTD**. A standard identifier has to be written to **ID[28:18]**.

### 2.3.43 TT Operation Configuration (TTOCF)

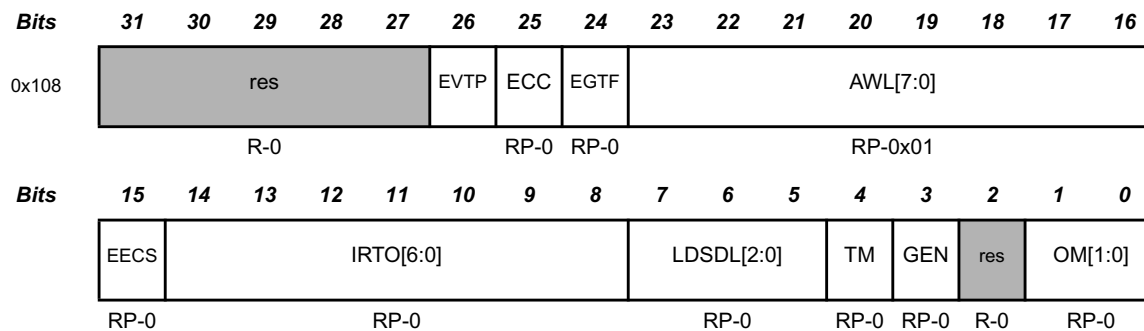

R = Read, P = Protected write; -n = value after reset

Table 44 TT Operation Configuration (address 0x108)

**Bit 26 EVTP:** Event Trigger Polarity

- 0= Rising edge trigger
- 1= Falling edge trigger

**Bit 25 ECC:** Enable Clock Calibration

- 0= Automatic clock calibration in TTCAN Level 0,2 is disabled
- 1= Automatic clock calibration in TTCAN Level 0,2 is enabled

**Bit 24 EGTF:** Enable Global Time Filtering

- 0= Global time filtering in TTCAN Level 0,2 is disabled
- 1= Global time filtering in TTCAN Level 0,2 is enabled

**Bit 23:16 AWL[7:0]:** Application Watchdog Limit

The application watchdog can be disabled by programming **AWL** to 0x00.

- 0x00-FF Maximum time after which the application has to serve the application watchdog. The application watchdog is incremented once each 256 NTUs.

**Bit 15 EECS:** Enable External Clock Synchronization

If enabled, TUR configuration (**TURCF.NCL** only) may be updated during TTCAN operation.

- 0= External clock synchronization in TTCAN Level 0,2 disabled
- 1= External clock synchronization in TTCAN Level 0,2 enabled

**Bit 14:8 IRTO[6:0]:** Initial Reference Trigger Offset

- 0x00-7F Positive offset, range from 0 to 127

**Bit 7:5 LDSDL[2:0]:** LD of Synchronization Deviation Limit

The Synchronization Deviation Limit **SDL** is configured by its dual logarithm **LDSDL** with  $SDL = 2^{(LDSDL + 5)}$ . It should not exceed the clock tolerance given by the CAN bit timing configuration.

- 0x0-7 LD of Synchronization Deviation Limit ( $SDL \leq 32 \dots 4096$ )

**Bit 4 TM:** Time Master

- 0= Time Master function disabled
- 1= Potential Time Master

**Bit 3 GEN:** Gap Enable

- 0= Strictly time-triggered operation
- 1= External event-synchronized time-triggered operation

- Bit 1:0 OM[1:0]:** Operation Mode  
 00= Event-driven CAN communication, default  
 01= TTCAN level 1  
 10= TTCAN level 2  
 11= TTCAN level 0

### 2.3.44 TT Matrix Limits (TTMLM)

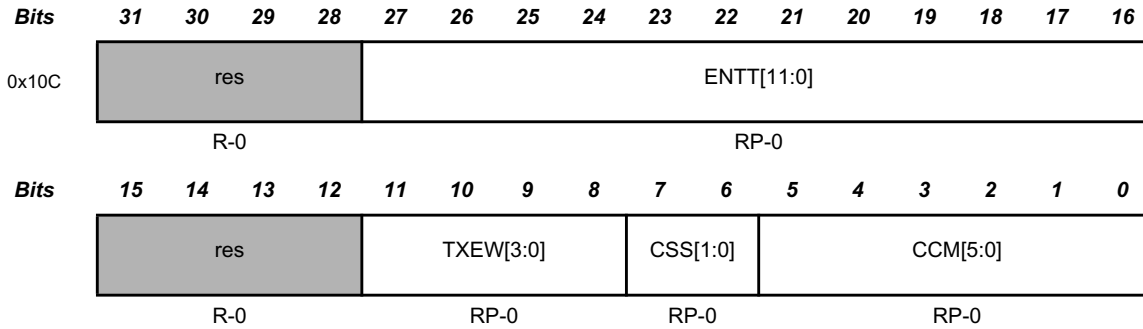

R = Read, P = Protected write; -n = value after reset

Table 45 TT Matrix Limits (address 0x10C)

- Bit 27:16 ENT[11:0]:** Expected Number of Tx Triggers  
 0x000-FFF Expected number of Tx Triggers in one Matrix Cycle
- Bit 11:8 TXEW[3:0]:** Tx Enable Window  
 0x0-F Length of Tx enable window, 1-16 NTU cycles
- Bit 7:6 CSS[1:0]:** Cycle Start Synchronization  
 Enables sync pulse output at pin **m\_ttcansoc**.  
 00= No sync pulse  
 01= Sync pulse at start of basic cycle  
 10= Sync pulse at start of matrix cycle  
 11= Reserved
- Bit 5:0 CCM[5:0]:** Cycle Count Max  
 0x00 1 Basic Cycle per Matrix Cycle  
 0x01 2 Basic Cycles per Matrix Cycle  
 0x03 4 Basic Cycles per Matrix Cycle  
 0x07 8 Basic Cycles per Matrix Cycle  
 0x0F 16 Basic Cycles per Matrix Cycle  
 0x1F 32 Basic Cycles per Matrix Cycle  
 0x3F 64 Basic Cycles per Matrix Cycle  
 others Reserved

**Note:** ISO 11898-4, Section 5.2.1 requires, that only the listed cycle count values are configured. Other values are possible but may lead to inconsistent matrix cycles.

### 2.3.45 TUR Configuration (TURCF)

The length of the NTU is given by:  $NTU = \text{CAN Clock Period} \cdot \mathbf{NC/DC}$

**NC** is an 18-bit value. Its high part, **NCH**[17:16] is hard wired to 0b01. Therefore the range of **NC** is 0x10000...0x1FFFF. The value configured by **NCL** is the initial value for **TURNA.NAV**[15:0]. **DC** is set to 0x1000 by hardware reset and it may not be written to 0x0000.

Level 1:  $\mathbf{NC} \geq 4 \cdot \mathbf{DC}$  and  $NTU = \text{CAN bit time}$

Level 0,2:  $\mathbf{NC} \geq 8 \cdot \mathbf{DC}$

The actual value of TUR may be changed by the clock drift compensation function of TTCAN Level 0 and Level 2 in order to adjust the node's local view of the NTU to the time master's view of the NTU. **DC** will not be changed by the automatic drift compensation, **TURNA.NAV** may be adjusted around **NC** in the range of the Synchronisation Deviation Limit given by **TTOCF.LDSDL**. **NC** and **DC** should be programmed to the largest suitable values in order to allow the best computational accuracy for the drift compensation process.

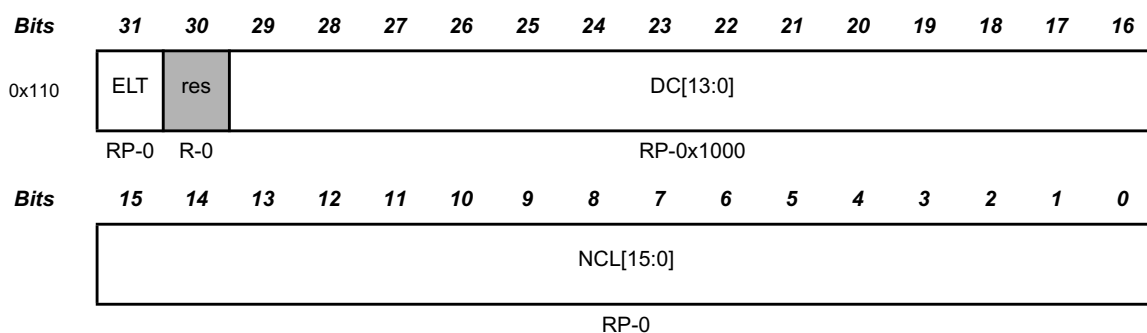

R = Read, P = Protected write; -n = value after reset

Table 46 TUR Configuration (address 0x110)

**Bit 31**      **ELT:**      Enable Local Time

0= Local time is stopped, default

1= Local time is enabled

**Note:** Local time is started by setting ELT. It remains active until ELT is reset or until the next hardware reset. TURCF.DC is locked when TURCF.ELT = '1'. If ELT is written to '0', the readable value will stay at '1' until the new value has been synchronized into the CAN clock domain. During this time write access to the other bits of the register remains locked.

**Bit 29:16**    **DC[13:0]:** Denominator Configuration

0x0000      Illegal value

0x0001-3FFF    Denominator Configuration

**Bit 15:0**      **NCL[15:0]:** Numerator Configuration Low

Write access to the TUR Numerator Configuration Low is only possible during configuration with **TURCF.ELT** = '0' or if **TTOCF.EECS** (external clock synchronization enabled) is set. When a new value for **NCL** is written outside TT Configuration Mode, the new value takes effect when **TTOST.WECS** is cleared to '0'. **NCL** is locked **TTOST.WECS** is '1'.

0x0000-FFFF    Numerator Configuration Low

**Note:** If  $\mathbf{NC} < 7 \cdot \mathbf{DC}$  in TTCAN Level 1, then it is required that subsequent time marks in the Trigger Memory must differ by at least 2 NTU.

**2.3.46 TT Operation Control (TTOCN)**

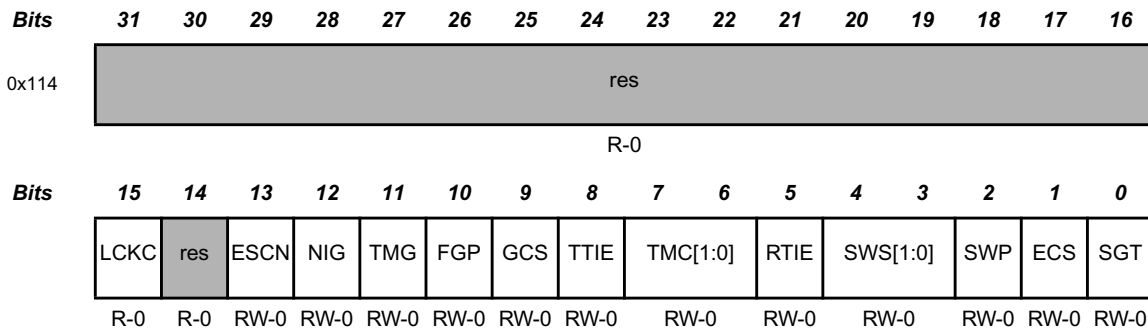

R = Read, P = Protected write; -n = value after reset

**Table 47** TT Operation Control (address 0x114)

**Bit 15 LCKC:** TT Operation Control Register Locked

Set by a write access to register TTOCN. Reset when the updated configuration has been synchronized into the CAN clock domain.

0= Write access to TTOCN enabled

1= Write access to TTOCN locked

**Bit 13 ESCN:** External Synchronization Control

If enabled the M\_TTCAN synchronizes its cycle time phase to an external event signalled by a rising edge at pin **m\_ttcan\_evt** (see Section 4.11).

0= External synchronization disabled

1= External synchronization enabled

**Bit 12 NIG:** Next is Gap

This bit can only be set when the M\_TTCAN is the actual Time Master and when it is configured for external event-synchronized time-triggered operation (**TTOCF.GEN** = '1')

0= No action, reset by reception of any reference message

1= Transmit next reference message with **Next\_is\_Gap** = '1'

**Bit 11 TMG:** Time Mark Gap

0= Reset by each reference message

1= Next reference message started when Register Time Mark interrupt **TTIR.RTMI** is activated

**Bit 10 FGP:** Finish Gap

Set by the CPU, reset by each reference message

0= No reference message requested

1= Application requested start of reference message

**Bit 9 GCS:** Gap Control Select

0= Gap control independent from **m\_ttcan\_evt**

1= Gap control by input pin **m\_ttcan\_evt**

**Bit 8 TTIE:** Trigger Time Mark Interrupt Pulse Enable

External time mark events are configured by trigger memory element **TMEX** (see Section 2.4.7). A trigger time mark interrupt pulse is generated when the trigger memory element becomes active, and the M\_TTCAN is in synchronization state In\_Schedule or In\_Gap.

0= Trigger Time Mark Interrupt output **m\_ttcan\_tmp** disabled

1= Trigger Time Mark Interrupt output **m\_ttcan\_tmp** enabled

**Bit 7:6 TMC[1:0]:** Register Time Mark Compare

- 00= No Register Time Mark Interrupt generated
- 01= Register Time Mark Interrupt if Time Mark = cycle time
- 10= Register Time Mark Interrupt if Time Mark = local time
- 11= Register Time Mark Interrupt if Time Mark = global time

**Note:** *When changing the time mark reference (cycle, local, global time), it is recommended to first write TMC = "00", then reconfigure TTTMK, and finally set TMC to the intended time reference.*

**Bit 5 RTIE:** Register Time Mark Interrupt Pulse Enable

Register time mark interrupts are configured by register **TTTMK**. A register time mark interrupt pulse with the length of one **m\_ttcn\_clk** period is generated when the time referenced by **TTOCN.TMC** (cycle, local, or global) equals **TTTMK.TM**, independent of the synchronization state.

- 0= Register Time Mark Interrupt output **m\_ttcn\_rtp** disabled
- 1= Register Time Mark Interrupt output **m\_ttcn\_rtp** enabled

**Bit 4:3 SWS[1:0]:** Stop Watch Source

- 00= Stop Watch disabled
- 01= Actual value of cycle time is copied to **TTCPT.SWV**
- 10= Actual value of local time is copied to **TTCPT.SWV**
- 11= Actual value of global time is copied to **TTCPT.SWV**

**Bit 2 SWP:** Stop Watch Polarity

- 0= Rising edge trigger
- 1= Falling edge trigger

**Bit 1 ECS:** External Clock Synchronization

Writing a '1' to **ECS** sets **TTOST.WECS** if the node is the actual Time Master. **ECS** is reset after one Host clock period. The external clock synchronization takes effect at the start of the next basic cycle.

**Bit 0 SGT:** Set Global time

Writing a '1' to **SGT** sets **TTOST.WGDT** if the node is the actual Time Master. **SGT** is reset after one Host clock period. The global time preset takes effect when the node transmits the next reference message with the **Master\_Ref\_Mark** modified by the preset value written to **TTGTP**.

### 2.3.47 TT Global Time Preset (TTGTP)

If **TTOST.WGDT** is set, the next reference message will be transmitted with the **Master\_Ref\_Mark** modified by the preset value and with **Disc\_Bit** = '1', presetting the global time in all nodes simultaneously.

**TP** is reset to 0x0000 each time a reference message with **Disc\_Bit** = '1' becomes valid or if the node is not the current Time Master. **TP** is locked while **TTOST.WGTD** = '1' after setting **TTOCN.SGT** until the reference message with **Disc\_Bit** = '1' becomes valid or until the node is no longer the current Time Master.

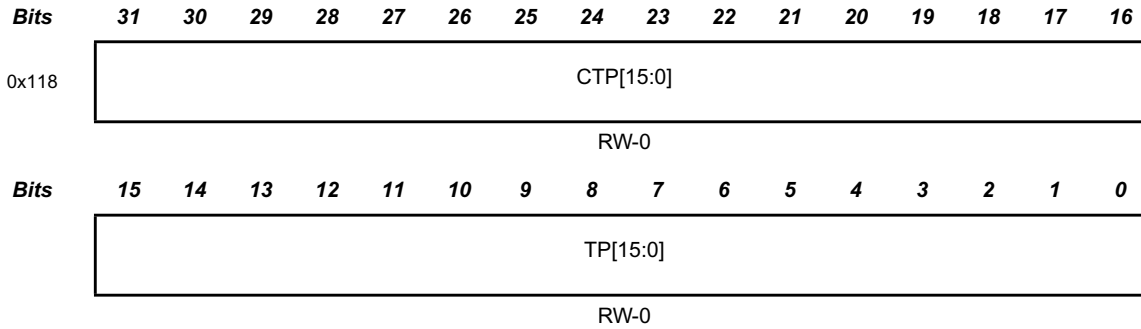

R = Read, P = Protected write; -n = value after reset

Table 48 TT Global Time Preset (address 0x118)

**Bit 31:16 CTP[15:0]:** Cycle Time Target Phase

**CTP** is write-protected while **TTOCN.ESCN** or **TTOST.SPL** are set (see Section 4.11).

0x0000-FFFF Defines target value of cycle time when a rising edge of **m\_ttcn\_evt** is expected

**Bit 15:0 TP[15:0]:** Time Preset

**TP** is write-protected while **TTOST.WGTD** is set.

0x0000-7FFF Next Master Reference Mark = Master Reference Mark + **TP**

0x8000 reserved

0x8001-FFFF Next Master Reference Mark = Master Reference Mark - (0x10000 - **TP**)

### 2.3.48 TT Time Mark (TTTMK)

A time mark interrupt (**TTIR.RTMI** = '1') is generated when the time base indicated by **TTOCN.TMC** (cycle time, local time, or global time) has the same value as **TM**.

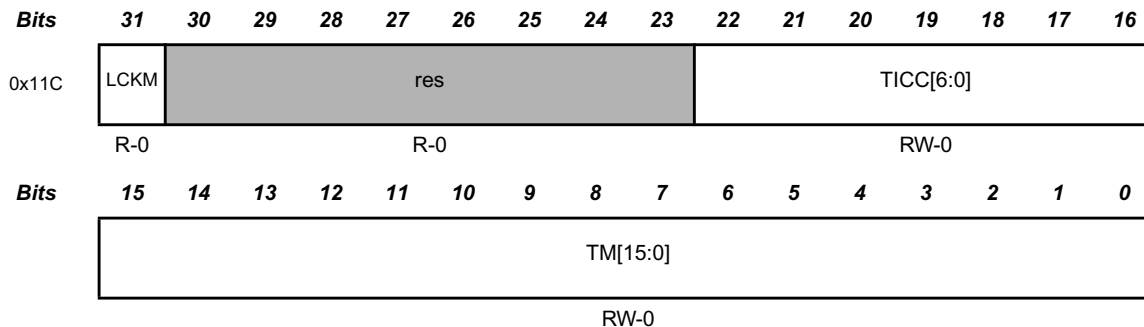

R = Read, P = Protected write; -n = value after reset

Table 49 TT Time Mark (address 0x11C)

#### Bit 31 LCKM: TT Time Mark Register Locked

Always set by a write access to registers **TTOCN**. Set by write access to register **TTTMK** when **TTOCN.TMC** ≠ "00". Reset when the registers have been synchronized into the CAN clock domain.

0= Write access to **TTTMK** enabled

1= Write access to **TTTMK** locked

#### Bit 22:16 TICC[6:0]: Time Mark Cycle Code

Cycle count for which the time mark is valid.

0b000000x valid for all cycles

0b000001c valid every second cycle at cycle count mod2 = c

0b00001cc valid every fourth cycle at cycle count mod4 = cc

0b0001ccc valid every eighth cycle at cycle count mod8 = ccc

0b001cccc valid every sixteenth cycle at cycle count mod16 = cccc

0b01ccccc valid every thirty-second cycle at cycle count mod32 = cccccc

0b1cccccc valid every sixty-fourth cycle at cycle count mod64 = ccccccc

#### Bit 15:0 TM[15:0]: Time Mark

0x0000-FFFF Time Mark

**Note:** When using byte access to register **TTTMK** it is recommended to first disable the time mark compare function (**TTOCN.TMC** = "00") to avoid compares on inconsistent register values.

**2.3.49 TT Interrupt Register (TTIR)**

The flags are set when one of the listed conditions is detected (edge-sensitive). The flags remain set until the Host clears them. A flag is cleared by writing a '1' to the corresponding bit position. Writing a '0' has no effect. A hard reset will clear the register.

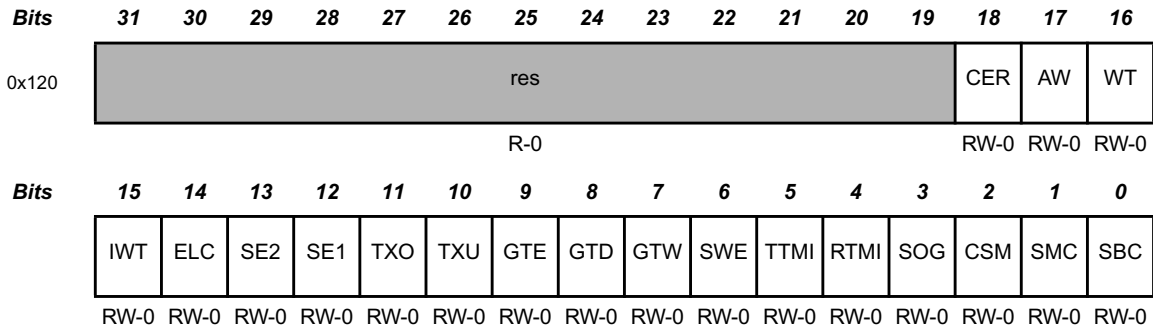

R = Read, W = Write; -n = value after reset

**Table 50 TT Interrupt Register (address 0x120)**

- Bit 18 CER:** Configuration Error  
Trigger out of order.  
0= No error found in trigger list  
1= Error found in trigger list
  
- Bit 17 AW:** Application Watchdog  
0= Application watchdog served in time  
1= Application watchdog not served in time
  
- Bit 16 WT:** Watch Trigger  
0= No missing reference message  
1= Missing reference message (Level 0: cycle time 0xFF00)
  
- Bit 15 IWT:** Initialization Watch Trigger  
The initialization is restarted by resetting **IWT**.  
0= No missing reference message during system startup  
1= No system startup due to missing reference message
  
- Bit 14 ELC:** Error Level Changed  
Not set when error level changed during initialization.  
0= No change in error level  
1= Error level changed
  
- Bit 13 SE2:** Scheduling Error 2  
0= No scheduling error 2  
1= Scheduling error 2 occurred
  
- Bit 12 SE1:** Scheduling Error 1  
0= No scheduling error 1  
1= Scheduling error 1 occurred
  
- Bit 11 TXO:** Tx Count Overflow  
0= Number of Tx Trigger as expected  
1= More Tx trigger than expected in one matrix cycle

- Bit 10 TXU:** Tx Count Underflow  
 0= Number of Tx Trigger as expected  
 1= Less Tx trigger than expected in one matrix cycle
- Bit 9 GTE:** Global Time Error  
 Synchronization deviation SD exceeds limit specified by **TTOCF.LDSDL**, TTCAN Level 0,2 only.  
 0= Synchronization deviation within limit  
 1= Synchronization deviation exceeded limit
- Bit 8 GTD:** Global Time Discontinuity  
 0= No discontinuity of global time  
 1= Discontinuity of global time
- Bit 7 GTW:** Global Time Wrap  
 0= No global time wrap occurred  
 1= Global time wrap from 0xFFFF to 0x0000 occurred
- Bit 6 SWE:** Stop Watch Event  
 0= No rising edge at stop watch trigger pin **m\_ttcan\_swt** detected  
 1= Rising edge at stop watch trigger pin **m\_ttcan\_swt** detected
- Bit 5 TTMI:** Trigger Time Mark Event Internal  
 Internal time mark events are configured by trigger memory element **TMIN** (see Section 2.4.7). Set when the trigger memory element becomes active, and the M\_TTCAN is in synchronization state In\_Gap or In\_Schedule.  
 0= Time mark not reached  
 1= Time mark reached (Level 0: cycle time **TTOCF.IRTO** • 0x200)
- Bit 4 RTMI:** Register Time Mark Interrupt  
 Set when time referenced by **TTOCN.TMC** (cycle, local, or global) equals **TTTMMK.TM**, independent of the synchronization state.  
 0= Time mark not reached  
 1= Time mark reached
- Bit 3 SOG:** Start of Gap  
 0= No reference message seen with Next\_is\_Gap bit set  
 1= Reference message with Next\_is\_Gap bit set becomes valid
- Bit 2 CSM:** Change of Synchronization Mode  
 0= No change in master to slave relation or schedule synchronization  
 1= Master to slave relation or schedule synchronization changed, also set when **TTOST.SPL** is reset
- Bit 1 SMC:** Start of Matrix Cycle  
 0= No Matrix Cycle started since bit has been reset  
 1= Matrix Cycle started
- Bit 0 SBC:** Start of Basic Cycle  
 0= No Basic Cycle started since bit has been reset  
 1= Basic Cycle started

### 2.3.50 TT Interrupt Enable (TTIE)

The settings in the TT Interrupt Enable register determine which status changes in the TT Interrupt Register will result in an interrupt.

0= TT interrupt disabled

1= TT interrupt enabled

Bits	31	30	29	28	27	26	25	24	23	22	21	20	19	18	17	16
0x124	res													CERE	AWE	WTE
	R-0													RW-0	RW-0	RW-0
Bits	15	14	13	12	11	10	9	8	7	6	5	4	3	2	1	0
	IWTE	ELCE	SE2E	SE1E	TXOE	TXUE	GTEE	GTDE	GTWE	SWEE	TTMIE	RTMIE	SOGE	CSME	SMCE	SBCE
	RW-0	RW-0	RW-0	RW-0	RW-0	RW-0	RW-0	RW-0	RW-0	RW-0	RW-0	RW-0	RW-0	RW-0	RW-0	RW-0

R = Read, W = Write; -n = value after reset

Table 51 TT Interrupt Enable (address 0x124)

<b>Bit 18</b>	<b>CERE:</b>	Configuration Error Interrupt Enable
<b>Bit 17</b>	<b>AWE:</b>	Application Watchdog Interrupt Enable
<b>Bit 16</b>	<b>WTE:</b>	Watch Trigger Interrupt Enable
<b>Bit 15</b>	<b>IWTE:</b>	Initialization Watch Trigger Interrupt Enable
<b>Bit 14</b>	<b>ELCE:</b>	Change Error Level Interrupt Enable
<b>Bit 13</b>	<b>SE2E:</b>	Scheduling Error 2 Interrupt Enable
<b>Bit 12</b>	<b>SE1E:</b>	Scheduling Error 1 Interrupt Enable
<b>Bit 11</b>	<b>TXOE:</b>	Tx Count Overflow Interrupt Enable
<b>Bit 10</b>	<b>TXUE:</b>	Tx Count Underflow Interrupt Enable
<b>Bit 9</b>	<b>GTEE:</b>	Global Time Error Interrupt Enable
<b>Bit 8</b>	<b>GTDE:</b>	Global Time Discontinuity Interrupt Enable
<b>Bit 7</b>	<b>GTWE:</b>	Global Time Wrap Interrupt Enable
<b>Bit 6</b>	<b>SWEE:</b>	Stop Watch Event Interrupt Enable
<b>Bit 5</b>	<b>TTMIE:</b>	Trigger Time Mark Event Internal Enable
<b>Bit 4</b>	<b>RTMIE:</b>	Register Time Mark Interrupt Enable
<b>Bit 3</b>	<b>SOGE:</b>	Start of Gap Interrupt Enable
<b>Bit 2</b>	<b>CSME:</b>	Change of Synchronization Mode Interrupt Enable
<b>Bit 1</b>	<b>SMCE:</b>	Start of Matrix Cycle Interrupt Enable
<b>Bit 0</b>	<b>SBCE:</b>	Start of Basic Cycle Interrupt Enable

### 2.3.51 TT Interrupt Line Select (TTILS)

The TT Interrupt Line Select register assigns an interrupt generated by a specific interrupt flag from the TT Interrupt Register to one of the two module interrupt lines. For interrupt generation the respective interrupt line has to be enabled via **ILE.EINT0** and **ILE.EINT1**.

0= TT interrupt assigned to interrupt line **m\_ttcant\_int0**

1= TT interrupt assigned to interrupt line **m\_ttcant\_int1**

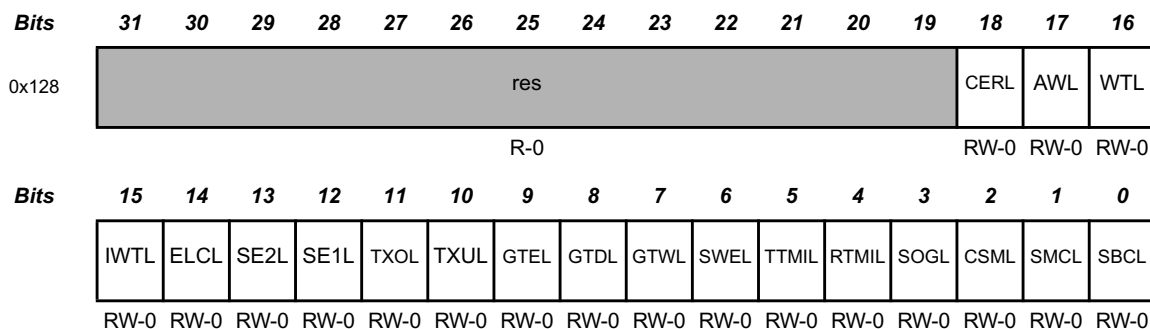

R = Read, W = Write; -n = value after reset

Table 52 TT Interrupt Line Select (address 0x128)

<b>Bit 18</b>	<b>CERL:</b>	Configuration Error Interrupt Line
<b>Bit 17</b>	<b>AWL:</b>	Application Watchdog Interrupt Line
<b>Bit 16</b>	<b>WTL:</b>	Watch Trigger Interrupt Line
<b>Bit 15</b>	<b>IWTL:</b>	Initialization Watch Trigger Interrupt Line
<b>Bit 14</b>	<b>ELCL:</b>	Change Error Level Interrupt Line
<b>Bit 13</b>	<b>SE2L:</b>	Scheduling Error 2 Interrupt Line
<b>Bit 12</b>	<b>SE1L:</b>	Scheduling Error 1 Interrupt Line
<b>Bit 11</b>	<b>TXOL:</b>	Tx Count Overflow Interrupt Line
<b>Bit 10</b>	<b>TXUL:</b>	Tx Count Underflow Interrupt Line
<b>Bit 9</b>	<b>GTEL:</b>	Global Time Error Interrupt Line
<b>Bit 8</b>	<b>GTDL:</b>	Global Time Discontinuity Interrupt Line
<b>Bit 7</b>	<b>GTWL:</b>	Global Time Wrap Interrupt Line
<b>Bit 6</b>	<b>SWEL:</b>	Stop Watch Event Interrupt Line
<b>Bit 5</b>	<b>TTMIL:</b>	Trigger Time Mark Event Internal Line
<b>Bit 4</b>	<b>RTMIL:</b>	Register Time Mark Interrupt Line
<b>Bit 3</b>	<b>SOGL:</b>	Start of Gap Interrupt Line
<b>Bit 2</b>	<b>CSML:</b>	Change of Synchronization Mode Interrupt Line
<b>Bit 1</b>	<b>SMCL:</b>	Start of Matrix Cycle Interrupt Line
<b>Bit 0</b>	<b>SBCL:</b>	Start of Basic Cycle Interrupt Line

### 2.3.52 TT Operation Status (TTOST)

Bits	31	30	29	28	27	26	25	24	23	22	21	20	19	18	17	16
0x12C	SPL	WECS	AWE	WFE	GSI	TMP[2:0]			GFI	WGTD	res					
	R-0	R-0	R-0	R-0	R-0	R-0			R-0	R-0	R-0					
Bits	15	14	13	12	11	10	9	8	7	6	5	4	3	2	1	0
	RTO[7:0]								QCS	QGTP	SYS[1:0]		MS[1:0]		EL[1:0]	
	R-0								R-1	R-0	R-0		R-0		R-0	

R = Read, P = Protected write; -n = value after reset

Table 53 TT Operation Status (address 0x12C)

**Bit 31 SPL:** Schedule Phase Lock

The bit is valid only when external synchronization is enabled (**TTOCN.ESCN** = '1'). In this case it signals that the difference between cycle time configured by **TTGTP.CTP** and the cycle time at the rising edge at pin **m\_ttcn\_evt** is less or equal 9 NTU (see Section 4.11).

- 0= Phase outside range
- 1= Phase inside range

**Bit 30 WECS:** Wait for External Clock Synchronization

- 0= No external clock synchronization pending
- 1= Node waits for external clock synchronization to take effect. The bit is reset at the start of the next basic cycle.

**Bit 29 AWE:** Application Watchdog Event

The application watchdog is served by reading TTOST. When the watchdog is not served in time, bit **AWE** is set, all TTCAN communication is stopped, and the M\_TTCAN is set into Bus Monitoring Mode.

- 0= Application Watchdog served in time
- 1= Failed to serve Application Watchdog in time

**Bit 28 WFE:** Wait for Event

- 0= No Gap announced, reset by a reference message with **Next\_is\_Gap** = '0'
- 1= Reference message with **Next\_is\_Gap** = '1' received

**Bit 27 GSI:** Gap Started Indicator

- 0= No Gap in schedule, reset by each reference message and for all time slaves
- 1= Gap time after Basic Cycle has started

**Bit 26:24 TMP[2:0]:** Time Master Priority

- 0x0-7 Priority of actual Time Master

**Bit 23 GFI:** Gap Finished Indicator

Set when the CPU writes **TTOCN.FGP**, or by a time mark interrupt if **TMG** = '1', or via input pin **m\_ttcn\_evt** if **TTOCN.GCS** = '1'. Not set by Ref\_Trigger\_Gap or when Gap is finished by another node sending a reference message.

- 0= Reset at the end of each reference message
- 1= Gap finished by M\_TTCAN

- Bit 22**      **WGTD:**    Wait for Global Time Discontinuity
- 0= No global time preset pending
  - 1= Node waits for the global time preset to take effect. The bit is reset when the node has transmitted a reference message with **Disc\_Bit** = '1' or after it received a reference message.
- Bit 15:8**      **RTO[7:0]:** Reference Trigger Offset
- The Reference Trigger Offset value is a signed integer with a range from -127 (0x81) to 127 (0x7F). There is no notification when the lower limit of -127 is reached. In case the M\_TTCAN becomes Time Master (**MS[1:0]** = "11"), the reset of **RTO** is delayed due to synchronization between Host and CAN clock domain. For time slaves the value configured by **TTOCF.IRTO** is read.
- 0x00-FF      Actual Reference Trigger offset value
- Bit 7**          **QCS:**      Quality of Clock Speed
- Only relevant in TTCAN Level 0 and Level 2, otherwise fixed to '1'.
- 0= Local clock speed not synchronized to Time Master clock speed
  - 1= Synchronization Deviation  $\leq$  **SDL**
- Bit 6**          **QGTP:**    Quality of Global Time Phase
- Only relevant in TTCAN Level 0 and Level 2, otherwise fixed to '0'.
- 0= Global time not valid
  - 1= Global time in phase with Time Master
- Bit 5:4**      **SYS[1:0]:** Synchronization State
- 00= Out of Synchronization
  - 01= Synchronizing to TTCAN communication
  - 10= Schedule suspended by Gap (In\_Gap)
  - 11= Synchronized to schedule (In\_Schedule)
- Bit 3:2**      **MS[1:0]:** Master State
- 00= Master\_Off, no master properties relevant
  - 01= Operating as Time Slave
  - 10= Operating as Backup Time Master
  - 11= Operating as current Time Master
- Bit 1:0**      **EL[1:0]:** Error Level
- 00= Severity 0 - No Error
  - 01= Severity 1 - Warning
  - 10= Severity 2 - Error
  - 11= Severity 3 - Severe Error

**2.3.53 TUR Numerator Actual (TURNA)**

There is no drift compensation in TTCAN Level 1 (**NAV = NC**). In TTCAN Level 0 and Level 2, the drift between the node's local clock and the time master's local clock is calculated. The drift is compensated when the Synchronisation Deviation (difference between **NC** and the calculated **NAV**) is not more than  $2^{(TTOCF.LDSDL + 5)}$ . With  $TTOCF.LDSDL \leq 7$ , this results in a maximum range for **NAV** of  $(NC - 0x1000) \leq NAV \leq (NC + 0x1000)$ .

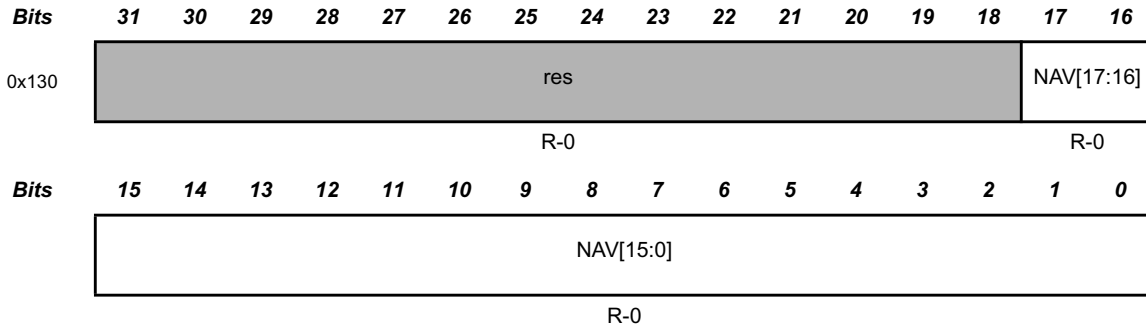

R = Read, P = Protected write; -n = value after reset

**Table 54** TUR Numerator Actual (address 0x130)

**Bit 17:0 NAV[17:0]:** Numerator Actual Value  
 $\leq 0x0EFFF$  Illegal value  
 $0x0F000-20FFF$  Actual numerator value  
 $\geq 0x21000$  Illegal value

**2.3.54 TT Local & Global Time (TTLGT)**

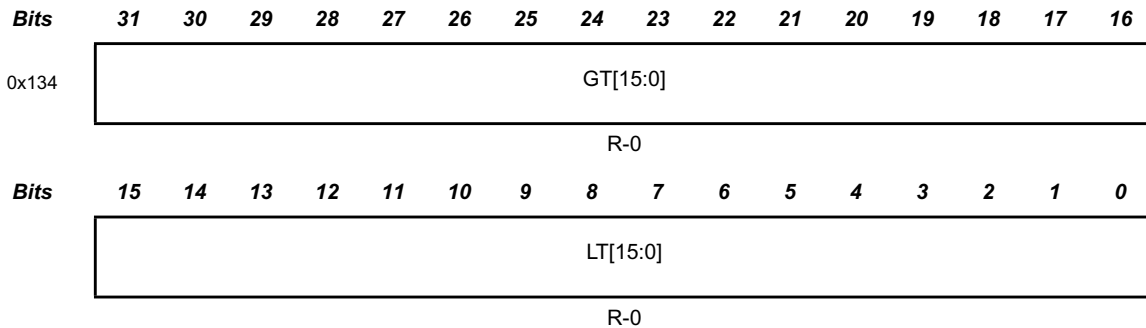

R = Read, P = Protected write; -n = value after reset

**Table 55** TT Local & Global Time (address 0x134)

**Bit 31:16 GT[15:0]:** Global Time  
 Non-fractional part of the sum of the node's local time and its local offset (see Section 4.5).  
 $0x0000-FFFF$  Global time value of TTCAN network

**Bit 15:0 LT[15:0]:** Local Time  
 Non-fractional part of local time, incremented once each local NTU (see Section 4.5).  
 $0x0000-FFFF$  Local time value of TTCAN node

**2.3.55 TT Cycle Time & Count (TTCTC)**

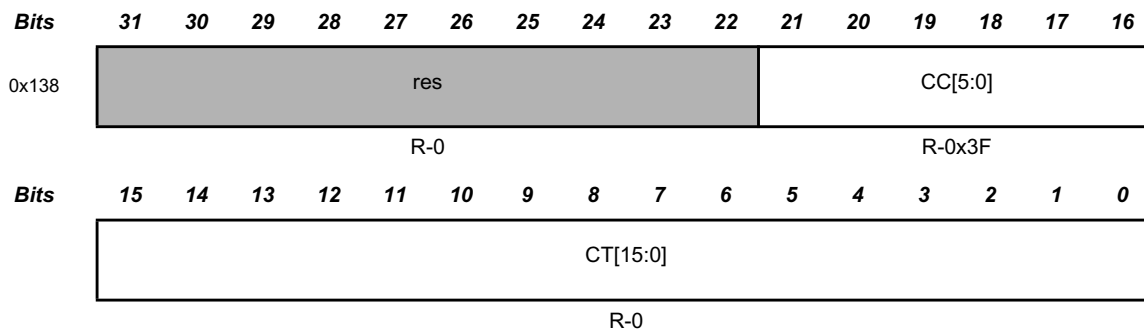

R = Read, P = Protected write; -n = value after reset

**Table 56 TT Cycle Time & Count (address 0x138)**

- Bit 21:16 CC[5:0]:** Cycle Count  
0x00-3F Number of actual Basic Cycle in the System Matrix
- Bit 15:0 CT[15:0]:** Cycle Time  
Non-fractional part of the difference of the node's local time and Ref\_Mark (see Section 4.5).  
0x0000-FFFF Cycle time value of TTCAN Basic Cycle

**2.3.56 TT Capture Time (TTCPT)**

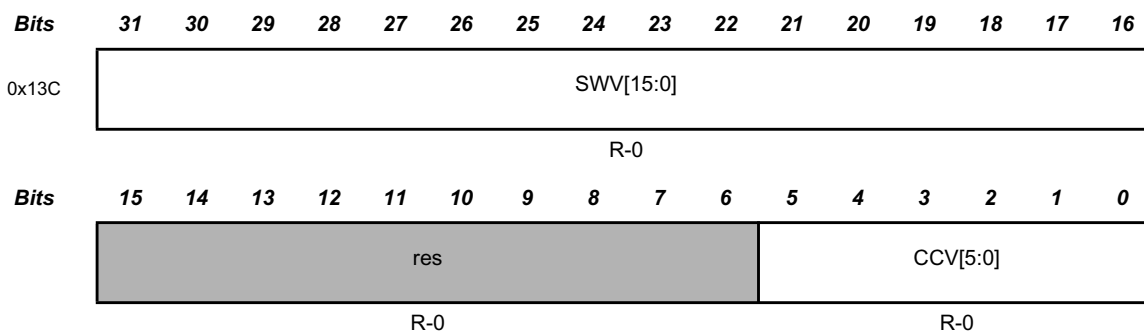

R = Read, P = Protected write; -n = value after reset

**Table 57 TT Capture Time (address 0x13C)**

- Bit 31:16 SWV[15:0]:** Stop Watch Value  
On a rising/falling edge (as configured via **TTOCN.SWP**) at the Stop Watch Trigger pin **m\_ttcn\_swt**, when **TTOCN.SWS** is ≠ "00" and **TTIR.SWE** is '0', the actual time value as selected by **TTOCN.SWS** (cycle, local, global) is copied to **SWV** and **TTIR.SWE** will be set to '1'. Capturing of the next stop watch value is enabled by resetting **TTIR.SWE**.  
0x0000-FFFF Captured Stop Watch value
- Bit 5:0 CCV[5:0]:** Cycle Count Value  
Cycle count value captured together with **SWV**.  
0x00-3F Captured cycle count value

**2.3.57 TT Cycle Sync Mark (TTCSM)**

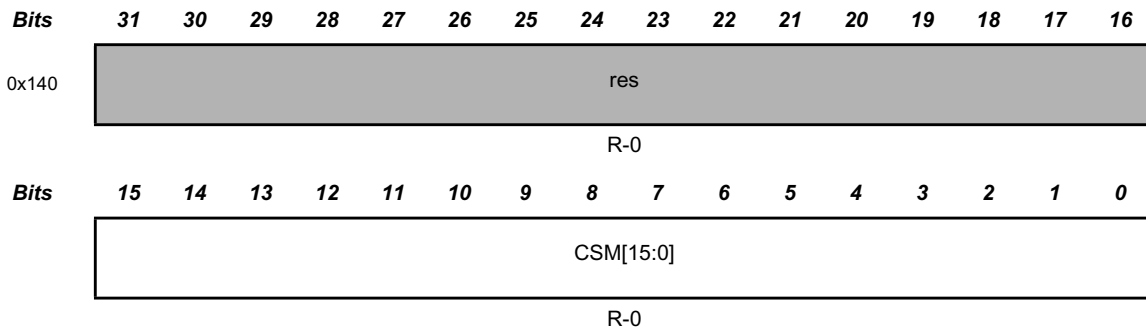

R = Read, P = Protected write; -n = value after reset

**Table 58** TT Cycle Sync Mark (address 0x140)

**Bit 15:0 CSM[15:0]:** Cycle Sync Mark

The Cycle Sync Mark is measured in cycle time. It is updated when the reference message becomes valid and retains its value until the next reference message becomes valid.

0x0000-FFFF Captured cycle time

## 2.4 Message RAM

For storage of Rx/Tx messages and for storage of the filter configuration a single- or dual-ported Message RAM has to be connected to the M\_TTCAN module.

### 2.4.1 Message RAM Configuration

The Message RAM has a width of 32 bits. In case parity checking or ECC is used a respective number of bits has to be added to each word. The M\_TTCAN module can be configured to allocate up to 1088 words in the Message RAM.

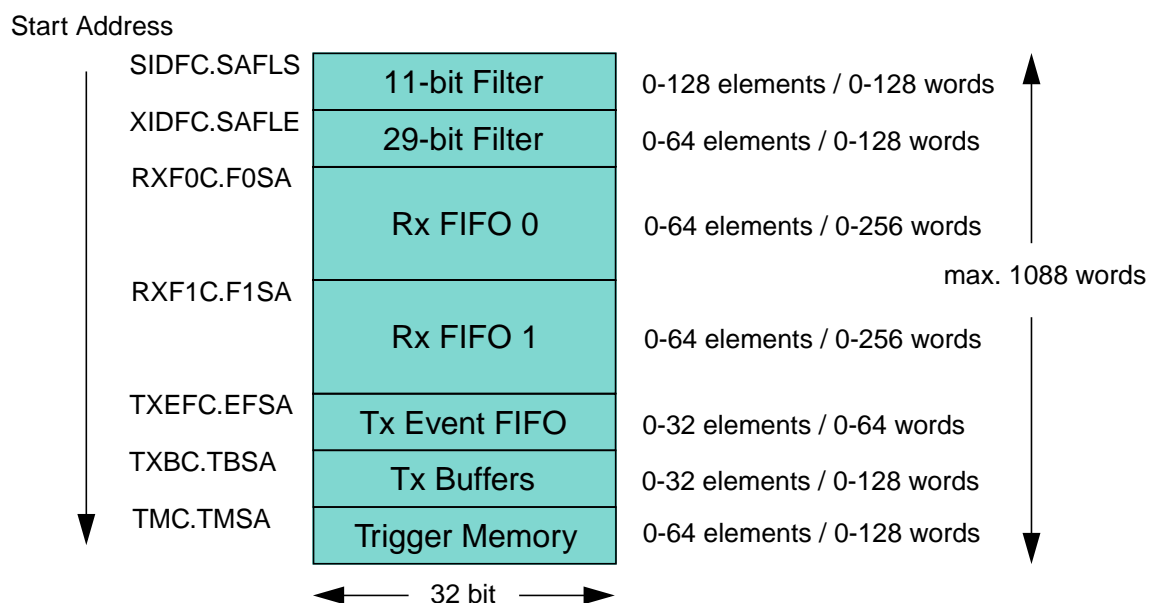

Figure 2 Message RAM Configuration

When the M\_TTCAN addresses the Message RAM it addresses 32-bit words, not single bytes. The configured start addresses are 32-bit word addresses.

## 2.4.2 Rx FIFO Element

Up to two Rx FIFOs can be configured in the Message RAM. Each Rx FIFO section can be configured to store up to 64 received messages. The structure of a Rx FIFO element is shown in Table 59 below.

	31	24	23	16	15	8	7	0
R0	res	XTD	RTR	ID[28:0]				
R1	ANMF	FIDX[6:0]		res	DLC[3:0]	RXTS[15:0]		
R2	DB3[7:0]		DB2[7:0]		DB1[7:0]		DB0[7:0]	
R3	DB7[7:0]		DB6[7:0]		DB5[7:0]		DB4[7:0]	

Table 59 Rx FIFO Element

### R0 Bit 30 XTD: Extended Identifier

Signals to the Host whether the received frame has a standard or extended identifier.

0= 11-bit standard identifier

1= 29-bit extended identifier

### R0 Bit 29 RTR: Remote Transmission Request

Signals to the Host whether the received frame is a data frame or a remote frame.

0= Received frame is a data frame

1= Received frame is a remote frame

### R0 Bits 28:0 ID[28:0]: Identifier

Standard or extended identifier depending on bit **XTD**. A standard identifier is stored into **ID[28:18]**.

### R1 Bit 31 ANMF: Accepted Non-matching Frame

Acceptance of non-matching frames may be enabled via **GFC.ANFS** and **GFC.ANFE**.

0= Received frame matching filter index **FIDX**

1= Received frame did not match any Rx filter element

### R1 Bits 30:24 FIDX[6:0]: Filter Index

0-127=Index of matching Rx acceptance filter element (invalid if **ANMF** = '1').

Range is 0 to **SIDFC.LSS** - 1 resp. **XIDFC.LSE** - 1.

### R1 Bits 19:16 DLC[3:0]: Data Length Code

0-8= Received frame has 0-8 data bytes

9-15=Received frame has 8 data bytes

### R1 Bits 15:0 RXTS[15:0]: Rx Timestamp

Timestamp Counter value captured on start of frame reception. Resolution depending on configuration of the Timestamp Counter Prescaler **TSCC.TCP**.

**R2 Bits 31:24DB3[7:0]:** Data Byte 3

**R2 Bits 23:16DB2[7:0]:** Data Byte 2

**R2 Bits 15:8 DB1[7:0]:** Data Byte 1

**R2 Bits 7:0 DB0[7:0]:** Data Byte 0

**R3 Bits 31:24DB7[7:0]:** Data Byte 7

**R3 Bits 23:16DB6[7:0]:** Data Byte 6

**R3 Bits 15:8 DB5[7:0]:** Data Byte 5

**R3 Bits 7:0 DB4[7:0]:** Data Byte 4

**2.4.3 Tx Buffer Element**

The Tx Buffers section can be configured to hold dedicated Tx Buffers as well as a Tx FIFO / Tx Queue. In case that the Tx Buffers section is shared by dedicated Tx buffers and a Tx FIFO / Tx Queue, the dedicated Tx Buffers start at the beginning of the Tx Buffers section followed by the buffers assigned to the Tx FIFO or Tx Queue. The Tx Handler distinguishes between dedicated Tx Buffers and Tx FIFO / Tx Queue by evaluating the Tx Buffer configuration **TXBC.TFQS** and **TXBC.NDTB**.

	31	24	23	16	15	8	7	0
T0	res	XTD	RTR	ID[28:0]				
T1	MM[7:0]		EFC	res	DLC[3:0]	res		
T2	DB3[7:0]		DB2[7:0]		DB1[7:0]		DB0[7:0]	
T3	DB7[7:0]		DB6[7:0]		DB5[7:0]		DB4[7:0]	

Table 60 Tx Buffer Element

**T0 Bit 30 XTD:** Extended Identifier

0= 11-bit standard identifier

1= 29-bit extended identifier

**T0 Bit 29 RTR:** Remote Transmission Request

0= Transmit data frame

1= Transmit remote frame

**T0 Bits 28:0 ID[28:0]:** Identifier

Standard or extended identifier depending on bit **XTD**. A standard identifier has to be written to **ID[28:18]**.

**T1 Bits 31:24MM[7:0]:** Message Marker

Written by CPU during Tx Buffer configuration. Copied into Tx Event FIFO element for identification of Tx message status.

**T1 Bit 23 EFC:** Event FIFO Control

0= Don't store Tx events

1= Store Tx events

**T1 Bits 19:16DLC[3:0]:** Data Length Code

0-8= Transmit frame with 0-8 data bytes

9-15=Transmit frame with 8 data bytes

**T2 Bits 31:24DB3[7:0]:** Data Byte 3**T2 Bits 23:16DB2[7:0]:** Data Byte 2**T2 Bits 15:8 DB1[7:0]:** Data Byte 1**T2 Bits 7:0 DB0[7:0]:** Data Byte 0**T3 Bits 31:24DB7[7:0]:** Data Byte 7**T3 Bits 23:16DB6[7:0]:** Data Byte 6**T3 Bits 15:8 DB5[7:0]:** Data Byte 5**T3 Bits 7:0 DB4[7:0]:** Data Byte 4

### 2.4.4 Tx Event FIFO Element

Each element stores information about transmitted messages. By reading the Tx Event FIFO the Host CPU gets this information in the order the messages were transmitted. Status information about the Tx Event FIFO can be obtained from register **TXEFS**.

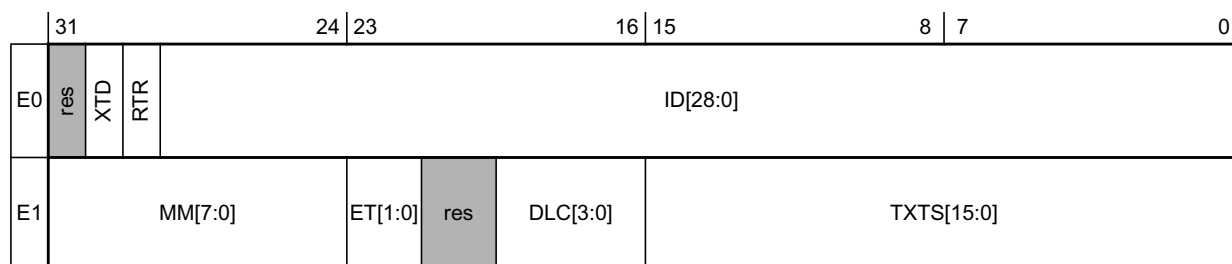

Table 61 Tx Event FIFO Element

**E0 Bit 30 XTD:** Extended Identifier

0= 11-bit standard identifier

1= 29-bit extended identifier

**E0 Bit 29 RTR:** Remote Transmission Request

0= Data frame transmitted

1= Remote frame transmitted

**E0 Bits 28:0 ID[28:0]:** Identifier

Standard or extended identifier depending on bit **XTD**. A standard identifier is stored into **ID[28:18]**.

**E1 Bits 31:24 MM[7:0]:** Message Marker

Copied from Tx Buffer into Tx Event FIFO element for identification of Tx message status.

**E1 Bit 23:22 ET[1:0]:** Event Type

00= Reserved

01= Tx event

10= Transmission in spite of cancellation (always set for transmissions in DAR mode)

11= Reserved

**E1 Bits 19:16 DLC[3:0]:** Data Length Code

0-8= Frame with 0-8 data bytes transmitted

9-15=Frame with 8 data bytes transmitted

**E1 Bits 15:0 TXTS[15:0]:** Tx Timestamp

Timestamp Counter value captured on start of frame transmission. Resolution depending on configuration of the Timestamp Counter Prescaler **TSCC.TCP**.

### 2.4.5 Standard Message ID Filter Element

Up to 128 filter elements can be configured for 11-bit standard IDs. When accessing a Standard Message ID Filter element, its address is the Filter List Standard Start Address **SIDFC.FLSSA** plus the index of the filter element (0...127).

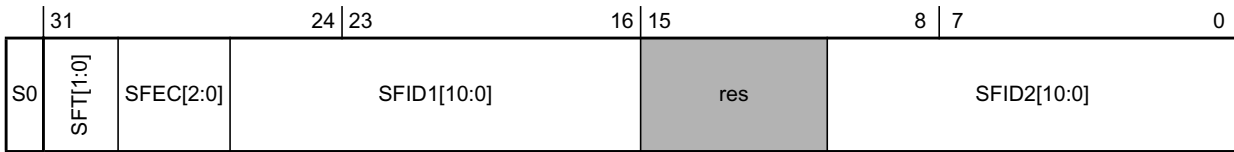

Table 62 Standard Message ID Filter Element

**Bits 31:30 SFT[1:0]:** Standard Filter Type

- 00= Range filter from **SF1ID** to **SF2ID** (**SF2ID** ≥ **SF1ID**)
- 01= Dual ID filter for **SF1ID** or **SF2ID**
- 10= Classic filter: **SF1ID** = filter, **SF2ID** = mask
- 11= Reserved

**Bit 29:27 SFEC[2:0]:** Standard Filter Element Configuration

All enabled filter elements are used for acceptance filtering of standard frames. Acceptance filtering stops at the first matching enabled filter element or when the end of the filter list is reached. If **SFEC** = "100", "101", or "110" a match sets interrupt flag **IE.HPM** and, if enabled, an interrupt is generated. In this case register **HPMS** is updated with the status of the priority match.

- 000= Disable filter element
- 001= Store in Rx FIFO 0 if filter matches
- 010= Store in Rx FIFO 1 if filter matches
- 011= Reject ID if filter matches
- 100= Set priority if filter matches
- 101= Set priority and store in FIFO 0 if filter matches
- 110= Set priority and store in FIFO 1 if filter matches
- 111= Reserved

**Bits 26:16 SFID1[10:0]:** Standard Filter ID 1

First ID of standard ID filter element.

**Bits 10:0 SFID2[10:0]:** Standard Filter ID 2

Second ID of standard ID filter element.

**Note:** In case a reserved value is configured, the filter element is considered disabled.

### 2.4.6 Extended Message ID Filter Element

Up to 64 filter elements can be configured for 29-bit extended IDs. When accessing an Extended Message ID Filter element, its address is the Filter List Extended Start Address **EIDFC.FLESA** plus two times the index of the filter element (0...63).

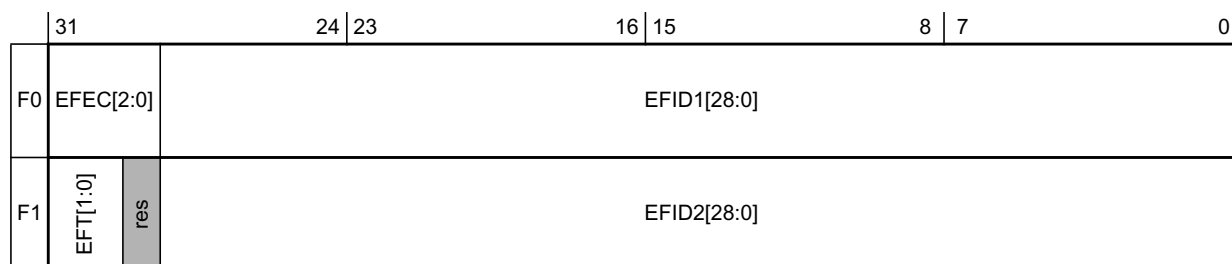

Table 63 Extended Message ID Filter Element

#### F0 Bit 31:29 EFEC[2:0]: Extended Filter Element Configuration

All enabled filter elements are used for acceptance filtering of extended frames. Acceptance filtering stops at the first matching enabled filter element or when the end of the filter list is reached. If **EFEC** = "100", "101", or "110" a match sets interrupt flag **IE.HPM** and, if enabled, an interrupt is generated. In this case register **HPMS** is updated with the status of the priority match.

- 000= Disable filter element
- 001= Store in Rx FIFO 0 if filter matches
- 010= Store in Rx FIFO 1 if filter matches
- 011= Reject ID if filter matches
- 100= Set priority if filter matches
- 101= Set priority and store in FIFO 0 if filter matches
- 110= Set priority and store in FIFO 1 if filter matches
- 111= Reserved

#### F0 Bits 28:0 EFID1[28:0]: Extended Filter ID 1

First ID of extended ID filter element.

#### F1 Bits 31:30 EFT[1:0]: Extended Filter Type

- 00= Range filter from **EF1ID** to **EF2ID** (**EF2ID** ≥ **EF1ID**)
- 01= Dual ID filter for **EF1ID** or **EF2ID**
- 10= Classic filter: **EF1ID** = filter, **EF2ID** = mask
- 11= Range filter from **EF1ID** to **EF2ID** (**EF2ID** ≥ **EF1ID**), XIDAM mask not applied

#### F1 Bits 28:0 EFID2[28:0]: Extended Filter ID 2

Second ID of extended ID filter element.

**Note:** In case a reserved value is configured, the filter element is considered disabled.

### 2.4.7 Trigger Memory Element

Up to 64 trigger memory elements can be configured. When accessing a Trigger Memory element, its address is the Trigger Memory Start Address **TTMC.TMSA** plus the index of the trigger memory element (0...63).

	31	24	23	16	15	8	7	0			
T0	TM[15:0]				res	CC[6:0]		ASC[1:0]	TMIN	TMEX	TYPE[3:0]
T1	res		FTYPE	MNR[6:0]		res				MSC[2:0]	

Table 64 Trigger Memory Element

#### T0 Bit 31:16 TM[15:0]: Time Mark

Cycle time for which the trigger becomes active.

#### T0 Bit 14:8 CC[6:0]: Cycle Code

Cycle count for which the trigger is valid. Ignored for trigger types Tx\_Ref\_Trigger, Tx\_Ref\_Trigger\_Gap, Watch\_Trigger, Watch\_Trigger\_Gap, End\_of\_List.

0b000000x valid for all cycles

0b000001c valid every 2nd cycle at cycle count mod2 = c

0b00001cc valid every 4th cycle at cycle count mod4 = cc

0b0001ccc valid every 8th cycle at cycle count mod8 = ccc

0b001cccc valid every 16th cycle at cycle count mod16 = cccc

0b01ccccc valid every 32nd cycle at cycle count mod32 = ccccc

0b1cccccc valid every 64th cycle at cycle count mod64 = ccccccc

#### T0 Bit 7:6 ASC[1:0]: Asynchronous Serial Communication

00= No ASC operation

01= Reserved

10= Node is ASC receiver

11= Node is ASC transmitter

#### T0 Bit 5 TMIN: Time Mark Event Internal

0= No action

1= **TTIR.TTMI** is set when trigger memory element becomes active

#### T0 Bit 4 TMEX: Time Mark Event External

0= No action

1= Pulse at output **m\_ttcn\_tmp** with the length of one **m\_ttcn\_clk** period is generated when the time mark of the trigger memory element becomes active and **TTCN.TTMIE** = '1'

**T0 Bit 3:0 TYPE[3:0]:** Trigger Type

0000= Tx\_Ref\_Trigger - valid when not in Gap

0001= Tx\_Ref\_Trigger\_Gap - valid when in Gap

0010= Tx\_Trigger\_Single - starts a single transmission in an exclusive time window

0011= Tx\_Trigger\_Continuous - starts continuous transmission in an exclusive time window

0100= Tx\_Trigger\_Arbitration - starts a transmission in an arbitrating time window

0101= Tx\_Trigger\_Merged - starts a merged arbitration window

0110= Watch\_Trigger - valid when not in Gap

0111= Watch\_Trigger\_Gap - valid when in Gap

1000= Rx\_Trigger - check for reception

1001= Time\_Base\_Trigger - only control **TMIN**, **TMEX**, and **ASC**

1010...1111=End\_of\_List - illegal type, causes config error

**Note: For ASC operation (ASC = "10", "11") only trigger types Rx\_Trigger and Time\_Base\_Trigger should be used.**

**T1 Bit 23 FTYPE:** Filter Type

0= 11-bit standard message ID

1= 29-bit extended message ID

**T1 Bit 22:16 MNR[6:0]:** Message Number

Transmission: Trigger is valid for configured Tx Buffer number. Valid values are 0 to 31.

Reception: Trigger is valid for standard / extended message ID filter element number. Valid values are 0 to 63 resp. 0 to 127.

**T1 Bits 2:0 MSC[2:0]:** Message Status Count

Counts scheduling errors for periodic messages in exclusive time windows. It has no function for arbitrating messages and in event-driven CAN communication (ISO11898-1).

0-7= Actual status

**Note: The trigger memory elements have to be written when the M\_TTCAN is in INIT state. Write access to the trigger memory elements outside INIT state is not allowed.**

***There is an exception for TMIN and TMEX when they are defined as part of a trigger memory element of TYPE Tx\_Ref\_Trigger. In this case they become active at the time mark modified by the actual Reference Trigger Offset (TTOST.RTO).***

# Chapter 3.

## 3. Functional Description

### 3.1 Operating Modes

#### 3.1.1 Software Initialization

Software initialization is started by setting bit **CCCR.INIT**, either by software or by a hardware reset, when an uncorrected bit error was detected in the Message RAM, or by going *Bus\_Off*. While **CCCR.INIT** is set, message transfer from and to the CAN bus is stopped, the status of the CAN bus output **m\_ttcn\_tx** is *recessive* (HIGH). The counters of the Error Management Logic EML are unchanged. Setting **CCCR.INIT** does not change any configuration register. Resetting **CCCR.INIT** finishes the software initialization. Afterwards the Bit Stream Processor BSP synchronizes itself to the data transfer on the CAN bus by waiting for the occurrence of a sequence of 11 consecutive *recessive* bits ( $\equiv$  *Bus\_Idle*) before it can take part in bus activities and start the message transfer.

Access to the M\_TTCAN configuration registers is only enabled when both bits **CCCR.INIT** and **CCCR.CCE** are set (protected write).

**CCCR.CCE** can only be set/reset while **CCCR.INIT** = '1'. **CCCR.CCE** is automatically reset when **CCCR.INIT** is reset.

The following registers are reset when **CCCR.CCE** is set

- **HPMS** - High Priority Message Status
- **RXF0S** - Rx FIFO 0 Status
- **RXF1S** - Rx FIFO 1 Status
- **TXFQS** - Tx FIFO/Queue Status
- **TXBRP** - Tx Buffer Request Pending
- **TXBTO** - Tx Buffer Transmission Occurred
- **TXBCF** - Tx Buffer Cancellation Finished
- **TXEFS** - Tx Event FIFO Status
- **TTOST** - TT Operation Status
- **TTLGT** - TT Local & Global Time, only Global Time **TTLGT.GT** is reset
- **TTCTC** - TT Cycle Time & Count
- **TTCSM** - TT Cycle Sync Mark

The Timeout Counter value **TOCV.TOC** is preset to the value configured by **TOCC.TOP** when **CCCR.CCE** is set.

In addition the state machines of the Tx Handler and Rx Handler are held in idle state while **CCCR.CCE** = '1'.

The following registers are only writeable while **CCCR.CCE** = '0'

- **TXBAR** - Tx Buffer Add Request
- **TXBCR** - Tx Buffer Cancellation Request

**CCCR.TEST** and **CCCR.MON** can only be set by the Host while **CCCR.INIT** = '1' and **CCCR.CCE** = '1'. Both bits may be reset at any time. **CCCR.DAR** can only be set/reset while **CCCR.INIT** = '1' and **CCCR.CCE** = '1'.

### 3.1.2 Normal Operation

The M\_TTCAN's default operating mode after hardware reset is event-driven CAN communication without time triggers (**TTOCF.OM** = "00"). It is required that both **CCCR.INIT** and **CCCR.CCE** are set before the TT Operation Mode can be changed.

Once the M\_TTCAN is initialized and **CCCR.INIT** is reset to zero, the M\_TTCAN synchronizes itself to the CAN bus and is ready for communication.

After passing the acceptance filtering, received messages including Message ID and DLC are stored into Rx FIFO 0 or Rx FIFO 1.

For messages to be transmitted dedicated Tx Buffers and/or a Tx FIFO or a Tx Queue can be initialized or updated. Automated transmission on reception of remote frames is not implemented.

### 3.1.3 Bus Monitoring Mode

The M\_TTCAN is set in Bus Monitoring Mode by programming **CCCR.MON** to *one* or when error level S3 (**TTOST.EL** = "11") is entered. In Bus Monitoring Mode (see ISO11898-1, 10.12 Bus monitoring), the M\_TTCAN is able to receive valid data frames and valid remote frames, but cannot start a transmission. In this mode, it sends only *recessive* bits on the CAN bus, if the M\_TTCAN is required to send a *dominant* bit (ACK bit, overload flag, active error flag), the bit is rerouted internally so that the M\_TTCAN monitors this *dominant* bit, although the CAN bus may remain in *recessive* state. In Bus Monitoring Mode register **TXBRP** is held in reset state.

The Bus Monitoring Mode can be used to analyze the traffic on a CAN bus without affecting it by the transmission of *dominant* bits. Figure 4 shows the connection of signals **m\_ttcn\_tx** and **m\_ttcn\_rx** to the M\_TTCAN in Bus Monitoring Mode.

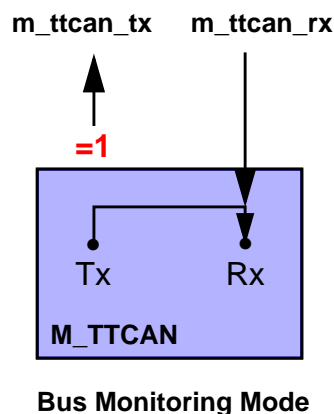

Figure 3 Pin Control in Bus Monitoring Mode

### 3.1.4 Disabled Automatic Retransmission

According to the CAN Specification (see ISO11898-1, 6.3.3 Recovery Management), the M\_TTCAN provides means for automatic retransmission of frames that have lost arbitration or that have been disturbed by errors during transmission. By default automatic retransmission is enabled. To support time-triggered communication as described in ISO 11898-1, chapter 9.2, the automatic retransmission may be disabled via **CCCR.DAR**.

#### 3.1.4.1 Frame Transmission in DAR Mode

In DAR mode all transmissions are automatically cancelled after they started on the CAN bus. A Tx Buffer's Tx Request Pending bit **TXBRP.TRPx** is reset after successful transmission, when a transmission has not yet been started at the point of cancellation, has been aborted due to lost arbitration, or when an error occurred during frame transmission.

- Successful transmission:  
Corresponding Tx Buffer Transmission Occurred bit **TXBTO.TOx** set  
Corresponding Tx Buffer Cancellation Finished bit **TXBCF.CFx** not set
- Successful transmission in spite of cancellation:  
Corresponding Tx Buffer Transmission Occurred bit **TXBTO.TOx** set  
Corresponding Tx Buffer Cancellation Finished bit **TXBCF.CFx** set
- Arbitration lost or frame transmission disturbed:  
Corresponding Tx Buffer Transmission Occurred bit **TXBTO.TOx** not set  
Corresponding Tx Buffer Cancellation Finished bit **TXBCF.CFx** set

In case of a successful frame transmission, and if storage of Tx events is enabled, a Tx Event FIFO element is written with Event Type **ET** = "10" (transmission in spite of cancellation).

### 3.1.5 Power Down (Sleep Mode)

The M\_TTCAN can be set into power down mode controlled by input signal **m\_ttcan\_clkstop\_req** or via CC Control Register **CCCR.CSR**. As long as the clock stop request signal **m\_ttcan\_clkstop\_req** is active, bit **CCCR.CSR** is read as *one*.

When all pending transmission requests have completed, the M\_TTCAN waits until bus idle state is detected. Then the M\_TTCAN sets then **CCCR.INIT** to *one* to prevent any further CAN transfers. Now the M\_TTCAN acknowledges that it is ready for power down by setting output signal **m\_ttcan\_clkstop\_ack** to *one* and **CCCR.CSA** to *one*. In this state, before the clocks are switched off, further register accesses can be made. A write access to **CCCR.INIT** will have no effect. Now the module clock inputs **m\_ttcan\_hclk** and **m\_ttcan\_cclk** may be switched off.

To leave power down mode, the application has to turn on the module clocks before resetting signal **m\_ttcan\_clkstop\_req** resp. CC Control Register flag **CCCR.CSR**. The M\_TTCAN will acknowledge this by resetting output signal **m\_ttcan\_clkstop\_ack** and resetting **CCCR.CSA**. Afterwards, the application can restart CAN communication by resetting bit **CCCR.INIT**.

### 3.1.6 Test Modes

To enable write access to register **TEST** (see Section 2.3.4), bit **CCCR.TEST** has to be set to *one*. This allows the configuration of the test modes and test functions.

Four output functions are available for the CAN transmit pin **m\_ttcan\_tx** by programming **TEST.TX**. Additionally to its default function – the serial data output – it can drive the CAN Sample Point signal to monitor the M\_TTCAN's bit timing and it can drive constant dominant or recessive values. The actual value at pin **m\_ttcan\_rx** can be read from **TEST.RX**. Both functions can be used to check the CAN bus' physical layer.

Due to the synchronization mechanism between CAN clock and Host clock domain, there may be a delay of several Host clock periods between writing to **TEST.TX** until the new configuration is visible at output pin **m\_ttcan\_tx**. This applies also when reading input pin **m\_ttcan\_rx** via **TEST.RX**.

**Note: Test modes should be used for production tests or self test only. The software control for pin m\_ttcan\_tx interferes with all CAN protocol functions. It is not recommended to use test modes for application.**

#### 3.1.6.1 Watchdog Mode

The application watchdog is served by reading register **TTOST**. When the application watchdog is not served in time, bit **TTOST.AWE** is set, all TTCAN communication is stopped, and the M\_TTCAN is set into Bus Monitoring Mode.

The TT Application Watchdog can be disabled by programming the Application Watchdog Limit **TTOCF.AWL** to 0x00. The TT Application Watchdog should not be disabled in a TTCAN application program.

### 3.1.6.2 External Loop Back Mode

The M\_TTCAN can be set in External Loop Back Mode by programming **TEST.LBCK** to *one*. In Loop Back Mode, the M\_TTCAN treats its own transmitted messages as received messages and stores them (if they pass acceptance filtering) into Rx FIFOs. Figure 4 shows the connection of signals **m\_ttcn\_tx** and **m\_ttcn\_rx** to the M\_TTCAN in External Loop Back Mode.

This mode is provided for hardware self-test. To be independent from external stimulation, the M\_TTCAN ignores acknowledge errors (recessive bit sampled in the acknowledge slot of a data/remote frame) in Loop Back Mode. In this mode the M\_TTCAN performs an internal feedback from its Tx output to its Rx input. The actual value of the **m\_ttcn\_rx** input pin is disregarded by the M\_TTCAN. The transmitted messages can be monitored at the **m\_ttcn\_tx** pin.

### 3.1.6.3 Internal Loop Back Mode

Internal Loop Back Mode is entered by programming bits **TEST.LBCK** and **CCCR.MON** to *one*. This mode can be used for a "Hot Selftest", meaning the M\_TTCAN can be tested without affecting a running CAN system connected to the pins **m\_ttcn\_tx** and **m\_ttcn\_rx**. In this mode pin **m\_ttcn\_rx** is disconnected from the M\_TTCAN and pin **m\_ttcn\_tx** is held *recessive*. Figure 4 shows the connection of **m\_ttcn\_tx** and **m\_ttcn\_rx** to the M\_TTCAN in case of Internal Loop Back Mode.

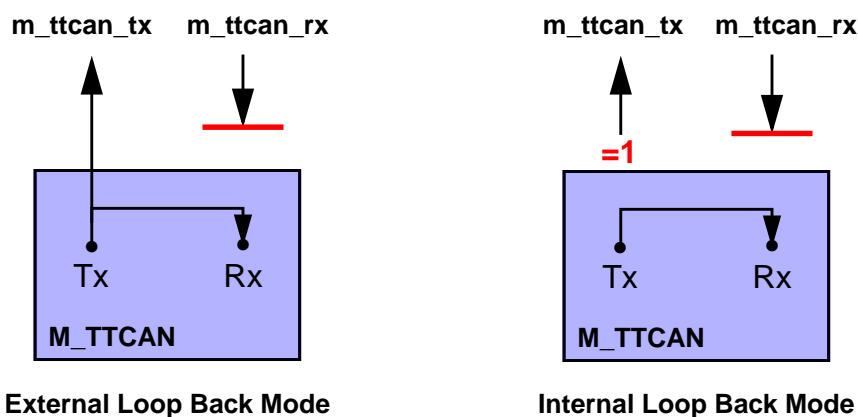

Figure 4 Pin Control in Loop Back Modes

### 3.2 Timestamp Generation

For timestamp generation the M\_TTCAN supplies a 16-bit wrap-around counter. A prescaler **TSCC.TCP** can be configured to clock the counter in multiples of CAN bit times (1...16). The counter is readable via **TSCV.TCV**. A write access to register **TSCV** resets the counter to zero. When the timestamp counter wraps around interrupt flag **IR.TSW** is set.

On start of frame reception / transmission the counter value is captured and stored into the timestamp section of a Rx FIFO (**RXTS[15:0]**) or Tx Event FIFO (**TXTS[15:0]**) element.

By programming bit **TSCC.EXT** an external 16-bit timestamp can be used.

### 3.3 Timeout Counter

To signal timeout conditions for Rx FIFO 0, Rx FIFO 1, and the Tx Event FIFO the M\_TTCAN supplies a 16-bit Timeout Counter. It operates as down-counter and uses the same prescaler controlled by **TSCC.TCP** as the Timestamp Counter. The Timeout Counter is configured via register **TOCC**. The actual counter value can be read from **TOCV.TOC**.

The Timeout Counter can only be started while **CCCR.INIT** = '0'. It is stopped when **CCCR.INIT** = '1', e.g. when the M\_TTCAN enters *Bus\_Off* state.

The operation mode is selected by **TOCC.TOS**. When operating in Continuous Mode, the counter starts when **CCCR.INIT** is reset. A write to **TOCV** presets the counter to the value configured by **TOCC.TOP** and continues down-counting.

When the Timeout Counter is controlled by one of the FIFOs, an empty FIFO presets the counter to the value configured by **TOCC.TOP**. Down-counting is started when the first FIFO element is stored. Writing to **TOCV** has no effect.

When the counter reaches zero, interrupt flag **IR.TOO** is set. In Continuous Mode, the counter is immediately restarted at **TOCC.TOP**.

**Note:** *The clock signal for the Timeout Counter is derived from the CAN Core's sample point signal. Therefore the point in time where the Timeout Counter is decremented may vary due to the synchronization / re-synchronization mechanism of the CAN Core.*

## 3.4 Rx Handling

The Rx Handler controls the acceptance filtering, the transfer of received messages to one of the two Rx FIFOs, as well as the Rx FIFO's Put and Get Indices.

### 3.4.1 Acceptance Filtering

The M\_TTCAN offers the possibility to configure two sets of acceptance filters, one for standard identifiers and one for extended identifiers. These filters can be assigned to Rx FIFO 0 or Rx FIFO 1. For acceptance filtering each list of filters is executed from element #0 until the first matching element. Acceptance filtering stops at the first matching element. The following filter elements are not evaluated for this message.

The main features are:

- Each filter element can be configured as
  - range filter (from - to)
  - filter for one or two dedicated IDs
  - classic bit mask filter
- Each filter element is configurable for acceptance or rejection filtering
- Each filter element can be enabled / disabled individually
- Filters are checked sequentially, execution stops with the first matching filter element

Related configuration registers are:

- Global Filter Configuration **GFC**
- Standard ID Filter Configuration **SIDFC**
- Extended ID Filter Configuration **XIDFC**
- Extended ID AND Mask **XIDAM**

Depending on the configuration of the filter element (**SFEC/EFEC**) a match triggers one of the following actions:

- Store received frame in FIFO 0 or FIFO 1
- Reject received frame
- Set High Priority Message interrupt flag **IR.HPM**
- Set High Priority Message interrupt flag **IR.HPM** and store received frame in FIFO 0 or FIFO 1

**Note:** *When an accepted message is written to one of the two Rx FIFOs, the unmodified received identifier is stored independent of the filter(s) used. The result of the acceptance filter process is strongly depending on the sequence of configured filter elements.*

#### 3.4.1.1 Range Filter

The filter matches for all received frames with Message IDs in the range defined by **SF1ID/SF2ID** resp. **EF1ID/EF2ID**.

There are two possibilities when range filtering is used together with extended frames:

**EFT = "00"**: The Message ID of received frames is ANDed with the Extended ID AND Mask (**XIDAM**) before the range filter is applied

**EFT = "11"**: The Extended ID AND Mask (**XIDAM**) is not used for range filtering

#### 3.4.1.2 Filter for dedicated IDs

A filter element can be configured to filter for one or two specific Message IDs. To filter for one specific Message ID, the filter element has to be configured with **SF1ID = SF2ID** resp. **EF1ID = EF2ID**.

### 3.4.1.3 Classic Bit Mask Filter

Classic bit mask filtering is intended to filter groups of Message IDs by masking single bits of a received Message ID. With classic bit mask filtering **SF1ID/EF1ID** is used as Message ID filter, while **SF2ID/EF2ID** is used as filter mask.

A zero bit at the filter mask will mask out the corresponding bit position of the configured ID filter, e.g. the value of the received Message ID at that bit position is not relevant for acceptance filtering. Only those bits of the received Message ID where the corresponding mask bits are one are relevant for acceptance filtering.

In case all mask bits are one, a match occurs only when the received Message ID and the Message ID filter are identical. If all mask bits are zero, all Message IDs match.

### 3.4.1.4 Standard Message ID Filtering

Figure 5 below shows the flow for standard Message ID (11-bit Identifier) filtering. The Standard Message ID Filter element is described in Section 2.4.5.

Controlled by the Global Filter Configuration **GFC** and the Standard ID Filter Configuration **SIDFC** Message ID, Remote Transmission Request bit (RTR), and the Identifier Extension bit (IDE) of received frames are compared against the list of configured filter elements.

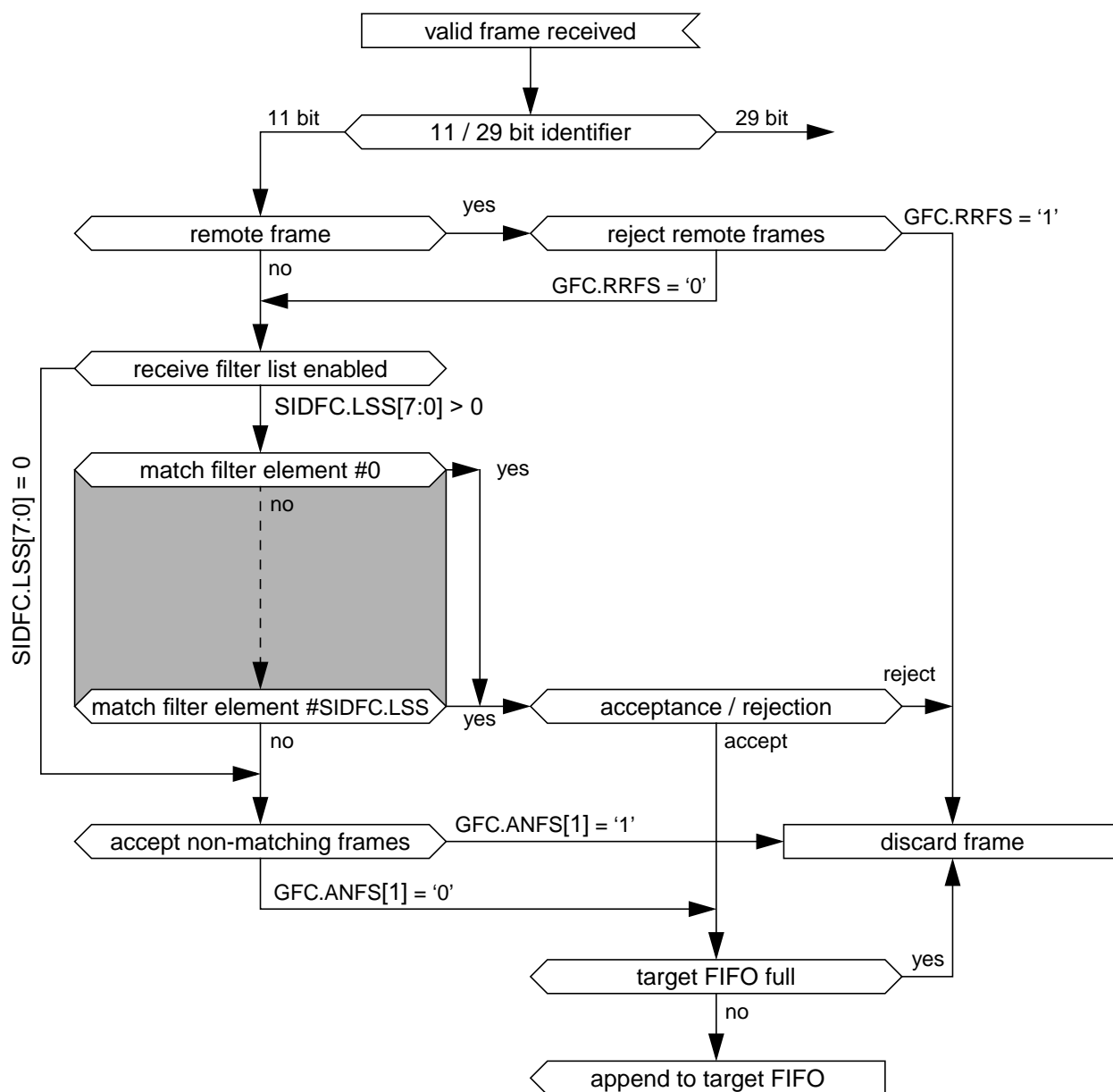

Figure 5 Standard Message ID Filter Path

**3.4.1.5 Extended Message ID Filtering**

Figure 6 below shows the flow for extended Message ID (29-bit Identifier) filtering. The Extended Message ID Filter element is described in Section 2.4.6.

Controlled by the Global Filter Configuration **GFC** and the Extended ID Filter Configuration **XIDFC** Message ID, Remote Transmission Request bit (RTR), and the Identifier Extension bit (IDE) of received frames are compared against the list of configured filter elements.

The Extended ID AND Mask **XIDAM** is ANDed with the received identifier before the filter list is executed.

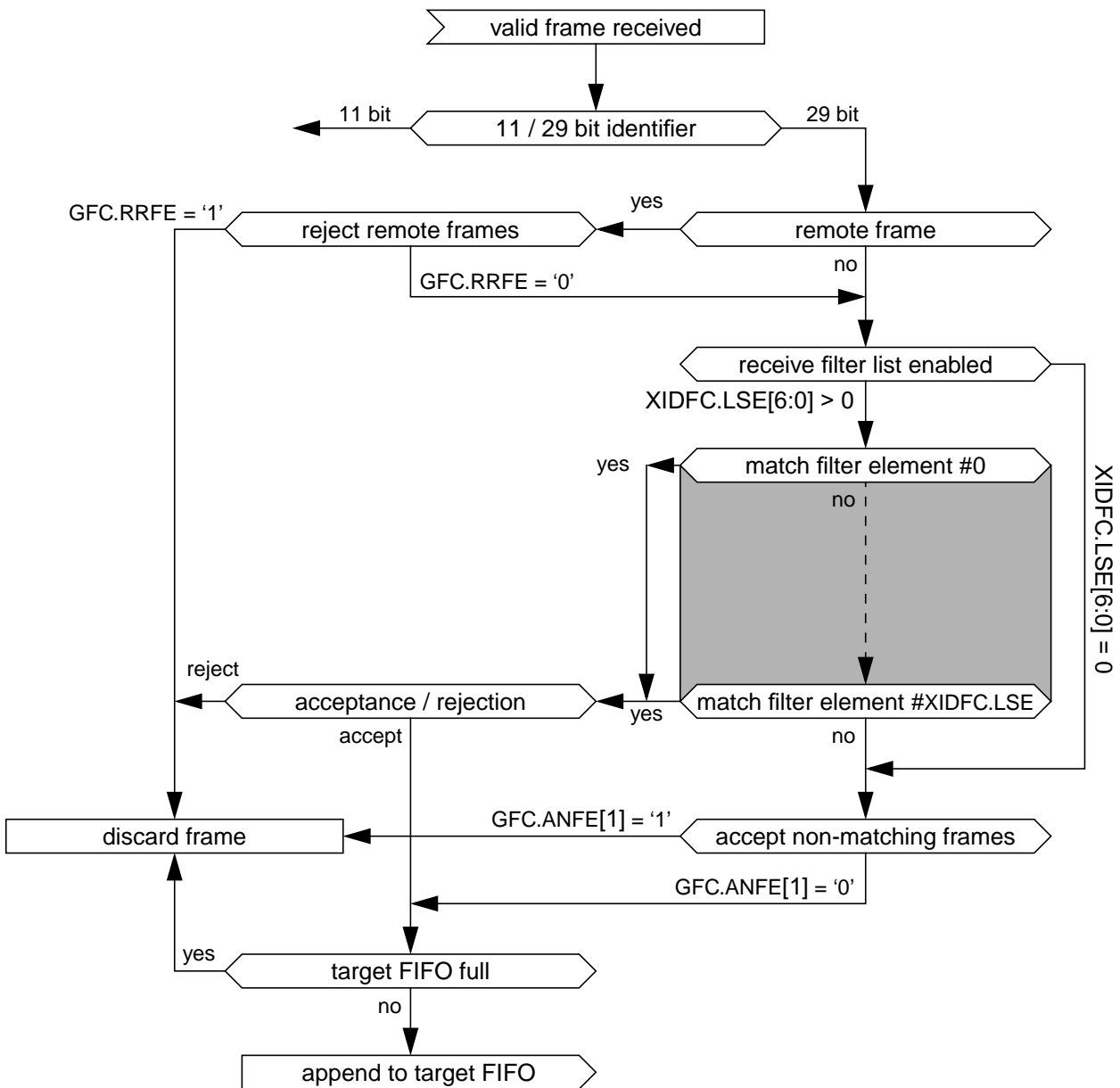

Figure 6 Extended Message ID Filter Path

### 3.4.2 Rx FIFOs

Rx FIFO 0 and Rx FIFO 1 can be configured to hold up to 64 elements each. Configuration of the two Rx FIFOs is done via registers **RXF0C** and **RXF1C**.

Received messages that passed acceptance filtering are transferred to the Rx FIFO as configured by the matching filter element. For a description of the filter mechanisms available for Rx FIFO 0 and Rx FIFO 1 see Section 3.4.1. The Rx FIFO element is described in Section 2.4.2.

When an Rx FIFO full condition is signalled by **IR.RFnF**, no further messages are written to the corresponding Rx FIFO until at least one message has been read out and the Rx FIFO Get Index has been incremented. In case a message is received while the corresponding Rx FIFO is full, this message is discarded and interrupt flag **IR.RFnL** is set.

To avoid an Rx FIFO overflow, the Rx FIFO watermark can be used. When the Rx FIFO fill level reaches the Rx FIFO watermark configured by **RXFnC.FnWM**, interrupt flag **IR.RFnW** is set.

When reading from an Rx FIFO, four times the Rx FIFO Get Index **RXFnS.FnGI** has to be added to the corresponding Rx FIFO start address **RXFnC.FnSA**.

### 3.5 Tx Handling

The Tx Handler handles transmission requests for the dedicated Tx Buffers, the Tx FIFO, and the Tx Queue. It controls the transfer of transmit messages to the CAN Core, the Put and Get Indices, and the Tx Event FIFO. Up to 32 Tx Buffers can be set up for message transmission. The Tx Buffer element is described in Section 2.4.3.

The Tx Handler starts a Tx scan to check for the highest priority pending Tx request (Tx Buffer with lowest Message ID) when the Tx Buffer Request Pending register **TXBRP** is updated, or when a transmission has been started.

**Note:** *AUTOSAR requires at least three Tx Queue Buffers and support of transmit cancellation*

#### 3.5.1 Dedicated Tx Buffers

Dedicated Tx Buffers are intended for message transmission under complete control of the Host CPU. Each Dedicated Tx Buffer is configured with a specific Message ID. In case that multiple Tx Buffers are configured with the same Message ID, the Tx Buffer with the lowest buffer number is transmitted first.

If the data section has been updated, a transmission is requested by an Add Request via **TXBAR.ARn**. The requested messages arbitrate internally with messages from an optional Tx FIFO or Tx Queue and externally with messages on the CAN bus, and are sent out according to their Message ID.

A Dedicated Tx Buffer allocates four 32-bit words in the Message RAM. Therefore the start address of a Dedicated Tx Buffer in the Message RAM is calculated by adding four times the transmit buffer index (0...31) to the Tx Buffer Start Address **TXBC.TBSA**.

#### 3.5.2 Tx FIFO

Tx FIFO operation is configured by programming **TXBC.TFQM** to '0'. Messages stored in the Tx FIFO are transmitted starting with the message referenced by the Get Index **TXFQS.TFGI**. After each transmission the Get Index is incremented cyclically until the Tx FIFO is empty. The Tx FIFO enables transmission of messages with the same Message ID from different Tx Buffers in the order these messages have been written to the Tx FIFO. The M\_TTCAN calculates the Tx FIFO Free Level **TXFQS.TFFL** as difference between Get and Put Index. It indicates the number of available (free) Tx FIFO elements.

New transmit messages have to be written to the Tx FIFO starting with the Tx Buffer referenced by the Put Index **TXFQS.TFQPI**. An Add Request increments the Put Index to the next free Tx FIFO element. When the Put Index reaches the Get Index, Tx FIFO Full (**TXFQS.TFQF** = '1') is signalled. In this case no further messages should be written to the Tx FIFO until the next message has been transmitted and the Get Index has been incremented.

When a single message is added to the Tx FIFO, the transmission is requested by writing a '1' to the **TXBAR** bit related to the Tx Buffer referenced by the Tx FIFO's Put Index.

When multiple (n) messages are added to the Tx FIFO, they are written to n consecutive Tx Buffers starting with the Put Index. The transmissions are then requested via **TXBAR**. The Put Index is then cyclically incremented by n. The number of requested Tx buffers should not exceed the number of free Tx Buffers as indicated by the Tx FIFO Free Level.

When a transmission request for the Tx Buffer referenced by the Get Index is cancelled, the Get Index is incremented to the next Tx Buffer with pending transmission request and the Tx FIFO Free Level is recalculated. When transmission cancellation is applied to any other Tx Buffer, the Get Index and the FIFO Free Level remain unchanged.

A Tx FIFO element allocates four 32-bit words in the Message RAM. Therefore the start address of the next available (free) Tx FIFO Buffer is calculated by adding four times the Put Index **TXFQS.TFQPI** (0...31) to the Tx Buffer Start Address **TXBC.TBSA**.

### 3.5.3 Tx Queue

Tx Queue operation is configured by programming **TXBC.TFQM** to '1'. Messages stored in the Tx Queue are transmitted starting with the message with the lowest Message ID (highest priority). In case that multiple Queue Buffers are configured with the same Message ID, the Queue Buffer with the lowest buffer number is transmitted first.

New messages have to be written to the Tx Buffer referenced by the Put Index **TXFQS.TFQPI**. An Add Request cyclically increments the Put Index to the next free Tx Buffer. In case that the Tx Queue is full (**TXFQS.TFQF** = '1'), the Put Index is not valid and no further message should be written to the Tx Queue until at least one of the requested messages has been sent out or a pending transmission request has been cancelled.

The application may use register **TXBRP** instead of the Put Index and may place messages to any Tx Buffer without pending transmission request.

A Tx Queue Buffer allocates four 32-bit words in the Message RAM. Therefore the start address of the next available (free) Tx Queue Buffer is calculated by adding four times the Tx Queue Put Index **TXFQS.TFQPI** (0...31) to the Tx Buffer Start Address **TXBC.TBSA**.

### 3.5.4 Mixed Dedicated Tx Buffers / Tx FIFO

In this case the Tx Buffers section in the Message RAM is subdivided into a set of Dedicated Tx Buffers and a Tx FIFO. The number of Dedicated Tx Buffers is configured by **TXBC.NDTB**. The number of Tx Buffers assigned to the Tx FIFO is configured by **TXBC.TFQS**. In case **TXBC.TFQS** is programmed to zero, only Dedicated Tx Buffers are used.

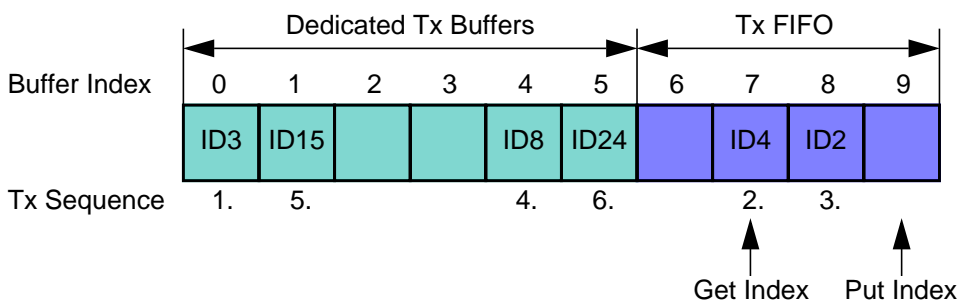

Figure 7 Example of mixed Configuration Dedicated Tx Buffers / Tx FIFO

Tx prioritization:

- Scan Dedicated Tx Buffers and oldest pending Tx FIFO Buffer (referenced by **TXFS.TFGI**)
- Buffer with lowest Message ID gets highest priority and is transmitted next

### 3.5.5 Mixed Dedicated Tx Buffers / Tx Queue

In this case the Tx Buffers section in the Message RAM is subdivided into a set of Dedicated Tx Buffers and a Tx Queue. The number of Dedicated Tx Buffers is configured by **TXBC.NDTB**. The number of Tx Queue Buffers is configured by **TXBC.TFQS**. In case **TXBC.TFQS** is programmed to zero, only Dedicated Tx Buffers are used.

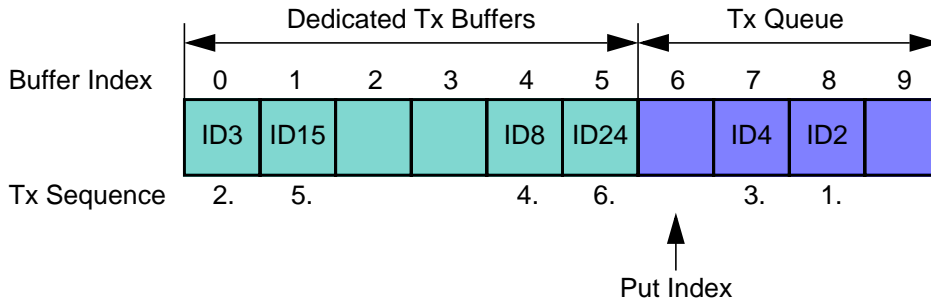

Figure 8 Example of mixed Configuration Dedicated Tx Buffers / Tx Queue

Tx prioritization:

- Scan all Tx Buffers with activated transmission request
- Tx Buffer with lowest Message ID gets highest priority and is transmitted next

### 3.5.6 Transmit Cancellation

The M\_TTCAN supports transmit cancellation. This feature is especially intended for gateway applications and AUTOSAR based applications. To cancel a requested transmission from a Dedicated Tx Buffer or a Tx Queue Buffer the Host has to write a '1' to the corresponding bit position (=number of Tx Buffer) of register **TXBCR**. Transmit cancellation is not intended for Tx FIFO operation.

Successful cancellation is signalled by setting the corresponding bit of register **TXBCF** to '1'.

In case a transmit cancellation is requested while a transmission from a Tx Buffer is already ongoing, the corresponding **TXBRP** bit remains set as long as the transmission is in progress. If the transmission was successful, the corresponding **TXBTO** and **TXBCF** bits are set. If the transmission was not successful, it is not repeated and only the corresponding **TXBCF** bit is set.

**Note:** *In case a pending transmission is cancelled immediately before this transmission could have been started, there follows a short time window where no transmission is started even if another message is also pending in this node. This may enable another node to transmit a message which may have a lower priority than the second message in this node.*

### 3.5.7 Tx Event Handling

To support Tx event handling the M\_TTCAN has implemented a Tx Event FIFO. After the M\_TTCAN has transmitted a message on the CAN bus, Message ID and timestamp are stored in a Tx Event FIFO element. To link a Tx event to a Tx Event FIFO element, the Message Marker from the transmitted Tx Buffer is copied into the Tx Event FIFO element.

The Tx Event FIFO can be configured to a maximum of 32 elements. The Tx Event FIFO element is described in Section 2.4.4.

When a Tx Event FIFO full condition is signalled by **IR.TEFF**, no further elements are written to the Tx Event FIFO until at least one element has been read out and the Tx Event FIFO Get Index has been incremented. In case a Tx event occurs while the Tx Event FIFO is full, this event is discarded and interrupt flag **IR.TEFL** is set.

To avoid a Tx Event FIFO overflow, the Tx Event FIFO watermark can be used. When the Tx Event FIFO fill level reaches the Tx Event FIFO watermark configured by **TXEFC.EFWM**, interrupt flag **IR.TEFW** is set.

When reading from the Tx Event FIFO, two times the Tx Event FIFO Get Index **TXEFS.EFGI** has to be added to the Tx Event FIFO start address **TXEFC.EFSA**.

## 3.6 FIFO Acknowledge Handling

The Get Indices of Rx FIFO 0, Rx FIFO 1, and the Tx Event FIFO are controlled by writing to the corresponding FIFO Acknowledge Index (see Section 2.3.25, Section 2.3.28, and Section 2.3.40). Writing to the FIFO Acknowledge Index will set the FIFO Get Index to the FIFO Acknowledge Index plus *one* and thereby updates the FIFO Fill Level. There are two use cases:

When only a single element has been read from the FIFO (the one being pointed to by the Get Index), this Get Index value is written to the FIFO Acknowledge Index.

When a sequence of elements has been read from the FIFO, it is sufficient to write the FIFO Acknowledge Index only once at the end of that read sequence (value: Index of the last element read), to update the FIFO's Get Index.

Due to the fact that the CPU has free access to the M\_TTCAN's Message RAM, special care has to be taken when reading FIFO elements in an arbitrary order (Get Index not considered). This might be useful when reading a High Priority Message from one of the two Rx FIFOs. In this case the FIFO's Acknowledge Index should not be written because this would set the Get Index to a wrong position and also alters the FIFO's Fill Level. In this case some of the older FIFO elements would be lost.

**Note:** *The application has to ensure that a valid value is written to the FIFO Acknowledge Index. The M\_CAN does not check for erroneous values.*

# Chapter 4.

## 4. TTCAN Operation

### 4.1 Reference Message

A reference message is a data frame characterized by a specific CAN identifier. It is received and accepted by all nodes except the Time Master (sender of the reference message).

For Level 1 the data length must be at least one; for Level 0,2 the data length must be at least four; otherwise, the message is not accepted as reference message. The reference message may be extended by other data up to the sum of eight CAN data bytes. All bits of the identifier except the three LSBs characterize the message as a reference message. The last three bits specify the priorities of up to 8 potential time masters. Reserved bits are transmitted as logical 0 and are ignored by the receivers. The reference message is configured via register TTRMC.

The time master transmits the reference message. If the reference message is disturbed by an error, it is retransmitted immediately. In case of a retransmission, the transmitted **Master\_Ref\_Mark** is updated. The reference message is sent periodically, but is allowed to stop the periodic transmission (**Next\_is\_Gap** bit) and to initiate transmission event-synchronized at the start of the next basic cycle by the current time master or by one of the other potential time masters.

The node transmitting the reference message is the current time master. The time master is allowed to transmit other messages. If the current time master fails, its function is replicated by the potential time master with the highest priority. Nodes that are neither time master nor potential time master are time-receiving nodes.

#### 4.1.1 Level 1

Level 1 operation is configured via **TTOCF.OM** = "01" and **TTOCF.GEN**. External clock synchronization is not available in Level 1.

The information related to the reference message is stored in the first data byte as shown in Table 65 below. **Cycle\_Count** is optional.

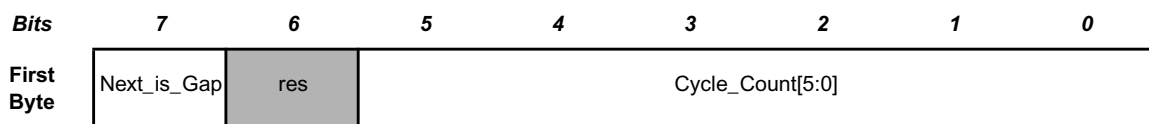

Table 65 First byte of Level 1 reference message

### 4.1.2 Level 2

Level 2 operation is configured via **TTOCF.OM** = “10” and **TTOCF.GEN**.

The information related to the reference message is stored in the first four data bytes as shown in Table 66 below. **Cycle\_Count** and the lower four bits of **NTU\_Res** are optional. The M\_TTCAN does not evaluate **NTU\_Res[3:0]** from received reference messages, it always transmits these bits as zero.

Bits	7	6	5	4	3	2	1	0
First Byte	Next_is_Gap	res	Cycle_Count[5:0]					
Second Byte	NTU_Res[6:4]			NTU_Res[3:0]			Disc_Bit	
Third Byte	Master_Ref_Mark[7:0]							
Fourth Byte	Master_Ref_Mark[15:8]							

Table 66 First four bytes of Level 2 reference message

### 4.1.3 Level 0

Level 0 operation is configured via **TTOCF.OM** = “11”. External event-synchronized time-triggered operation is not available in Level 0.

The information related to the reference message is stored in the first four data bytes as shown in Table 66 below. In Level 0 **Next\_is\_Gap** is always zero. **Cycle\_Count** and the lower four bits of **NTU\_Res** are optional. The M\_TTCAN does not evaluate **NTU\_Res[3:0]** from received reference messages, it always transmits these bits as zero.

Bits	7	6	5	4	3	2	1	0
First Byte	Next_is_Gap	res	Cycle_Count[5:0]					
Second Byte	NTU_Res[6:4]			NTU_Res[3:0]			Disc_Bit	
Third Byte	Master_Ref_Mark[7:0]							
Fourth Byte	Master_Ref_Mark[15:8]							

Table 67 First four bytes of Level 0 reference message

## 4.2 TTCAN Configuration

### 4.2.1 TTCAN Timing

The Network Time Unit NTU is the unit in which all times are measured. The NTU is a constant of the whole network and is defined a priori by the network system designer. In TTCAN Level 1 the NTU is the nominal CAN bit time. In TTCAN Level 0 and Level 2 the NTU is a fraction of the physical second.

The NTU is the time base for the local time. The integer part of the local time (16-bit value) is incremented once each NTU. Cycle time and global time are both derived from local time. The fractional part (3-bit value) of local time, cycle time, and global time is not readable.

In TTCAN Level 0 and Level 2 the length of the NTU is defined by the Time Unit Ratio TUR. The TUR is in principle a non-integer number and given by the formula  $TUR = \mathbf{TURNA.NAV} / \mathbf{TURCF.DC}$ . The length of the NTU is given by the formula  $NTU = \text{CAN Clock Period} \cdot TUR$ .

The TUR Numerator Configuration **NC** is an 18-bit number, **TURCF.NCL[15:0]** can be programmed in the range 0x0000-0xFFFF. **TURCF.NCH[17:16]** is hard wired to 0b01. When the number 0xnnnn is written to **TURCF.NCL[15:0]**, **TURNA.NAV** starts with the value  $0x10000 + 0x0nnnn = 0x1nnnn$ . The TUR Denominator Configuration **TURCF.DC** is a 14-bit number. **TURCF.DC** may be programmed in the range 0x0001 - 0x3FFF, 0x0000 is an illegal value.

In Level 1, **NC** must be  $\geq 4 \cdot \mathbf{TURCF.DC}$ . In Level 0,2 **NC** must be  $\geq 8 \cdot \mathbf{TURCF.DC}$  to allow the 3-bit resolution for the internal fractional part of the NTU.

A hardware reset presets **TURCF.DC** to 0x1000 and **TURCF.NCL** to 0x10000, resulting in an NTU consisting of 16 CAN clock periods. Local time and application watchdog are not started before either the **CCCR.INIT** is reset, or **TURCF.ELT** is set. **TURCF.ELT** may not be set before the NTU is configured. Setting **TURCF.ELT** to '1' also locks the write access to register **TURCF**.

At startup **TURNA.NAV** is updated from **NC** ( $= \mathbf{TURCF.NCL} + 0x10000$ ) when **TURCF.ELT** is set. In TTCAN Level 1 there is no drift compensation. **TURNA.NAV** does not change during operation, it always equals **NC**.

In TTCAN Level 0 and Level 2 there are two possibilities for **TURNA.NAV** to change. When operating as time slave or backup time master, and when **TTOCF.ECC** is set, **TURNA.NAV** is updated automatically to the value calculated from the monitored global time speed, as long as the M\_TTCAN is in synchronization state In\_Schedule or In\_Gap. When it loses synchronization it returns to **NC**. When operating as the actual time master, and when **TTOCF.EECS** is set, the Host may update **TURCF.NCL**. When the Host sets **TTOCN.ECS**, **TURNA.NAV** will be updated from the new value of **NC** at the next reference message. The status flag **TTOST.WECS** as is set when **TTOCN.ECS** is set and is cleared when **TURNA.NAV** is updated. **TURCF.NCL** is write locked while **TTOST.WECS** is set.

In TTCAN Level 0 and Level 2 the clock calibration process adapts **TURNA.NAV** in the range of the Synchronization Deviation Limit SDL of  $\mathbf{NC} \pm 2^{(\mathbf{TTOCF.LDSDL}+5)}$ . **TURCF.NCL** should be programmed to the largest applicable numerical value in order to achieve the best accuracy in the calculation of **TURNA.NAV**.

The synchronization deviation SD is the difference between **NC** and **TURNA.NAV** ( $SD = |\mathbf{NC} - \mathbf{TURNA.NAV}|$ ). It is limited by the Synchronization Deviation Limit SDL, which is configured by its dual logarithm **TTOCF.LDSDL** ( $SDL = 2^{(\mathbf{TTOCF.LDSDL}+5)}$ ) and should not exceed the clock tolerance given by the CAN bit timing configuration. SD is calculated at each new Basic Cycle. When the calculated **TURNA.NAV** deviates by more than SDL from **NC**, or if the **Disc\_Bit** in the reference message is set, the drift compensation is suspended and **TTIR.GTE** is set and **TTOSC.QCS** is reset, or in case of the **Disc\_Bit** = '1', **TTIR.GTD** is set.

TUR configuration examples are shown in Table 68 below.

<b>TUR</b>	<b>8</b>	<b>10</b>	<b>24</b>	<b>50</b>	<b>510</b>	<b>125000</b>	<b>32.5</b>	<b>100/12</b>	<b>529/17</b>
<b>NC</b>	0x1FFF8	0x1FFFE	0x1FFF8	0x1FFEA	0x1FFFE	0x1E848	0x1FFE0	0x19000	0x10880
<b>TURCF.DC</b>	0x3FFF	0x3333	0x1555	0x0A3D	0x0101	0x0001	0x0FC0	0x3000	0x0880

Table 68 *TUR Configuration Examples*

**TTOCN.ECS** schedules **NC** for activation by the next reference message. **TTOCN.SGT** schedules **TTGTP.TP** for activation by the next reference message. Setting of **TTOCN.ECS** and **TTOCN.SGT** requires **TTOCF.EECS** to be set (external clock synchronization enabled) while the M\_TTCAN is actual time master.

The M\_TTCAN module provides an application watchdog to verify the function of the application program. The Host has to serve this watchdog regularly, else all CAN bus activity is stopped. The Application Watchdog Limit **TTOCF.AWL** specifies the number of NTUs between two times the watchdog has to be served. The maximum number of NTUs is 256. The Application Watchdog is served by reading register TTOST. **TTOST.AWE** indicates whether the watchdog has been served in time. In case the application failed to serve the application watchdog, interrupt flag **TTIR.AW** is set. For software development, the application watchdog may be disabled by programming **TTOCF.AWL** to 0x00 (see also Section 3.1.6.1).

#### 4.2.1.1 *Timing of Interface Signals*

The timing events which cause a pulse at output **m\_ttcan\_tmp** and **m\_ttcan\_rtp** are generated in the CAN clock domain. There is a clock domain crossing delay to be considered before the same event is visible in the Host clock domain (**TTIR.TTMI** resp. **TTIR.RTMI** set). The signals can be connected e.g. to the timing input(s) of another TTCAN node (**m\_ttcan\_swt** / **m\_ttcan\_evt**), in order to automatically synchronize two TTCAN networks.

Output **m\_ttcan\_soc** gets active whenever a reference message is completed (either transmitted or received). The output is controlled in the Host clock domain.

#### 4.2.2 *Message Scheduling*

**TTOCF.TM** controls whether the M\_TTCAN operates as a potential time master or as a time slave. If it is a potential time master, the three LSBs of the reference message's identifier **TTRMC.RID** define the master priority, 0 giving the highest and 7 giving the lowest priority. There may not be two nodes in the network using the same master priority. **TTRMC.RID** is used for recognition of reference messages. **TTRMC.RMPS** is not relevant for time slaves.

The Initial Reference Trigger Offset **TTOCF.IRTO** is a 7-bit-value that defines (in NTUs) how long a backup time master waits before it starts the transmission of a reference message when a reference message is expected but the bus remains idle. The recommended value for **TTOCF.IRTO** is the master priority multiplied with a factor depending on the expected clock drift between the potential time masters in the network. The sequential order of the backup time masters, when one of them starts the reference message in case the current time master fails, should correspond to their master priority, even with maximum clock drift.

**TTOCF.OM** decides whether the node operates in TTCAN Level 0, Level 1, or Level 2. In one network, all potential time masters have to operate on the same level. Time slaves may operate on Level 1 in a Level 2 network, but not vice versa. The configuration of the TTCAN operation mode via **TTOCF.OM** is the last step in the setup. With **TTOCF.OM** = "00" (event-driven CAN communication), the M\_TTCAN operates according to ISO 11898-1, without time triggers. With **TTOCF.OM** = "01" (Level 1), the M\_TTCAN operates according to ISO 11898-4, but without the possibility to synchronize the basic cycles to external events, the **Next\_is\_Gap** bit in the reference message is ignored. With **TTOCF.OM** = "10" (Level 2), the M\_TTCAN operates according to ISO 11898-4, including the event-synchronized start of a basic cycle. With **TTOCF.OM** = "11" (Level 0), the M\_TTCAN operates as event-driven CAN but maintains a calibrated global time base as in Level 2.

**TTOCF.EECS** enables the external clock synchronisation, allowing the application program of the current time master to update the TUR configuration during time-triggered operation, to adapt the clock speed and (in Level 0,2 only) the global clock phase to an external reference.

**TTMLM.ENTT** in the TT Matrix Limits register specifies the number of expected Tx\_Triggers in the system matrix. This is the sum of Tx\_Triggers for exclusive, single arbitrating and merged arbitrating windows, excluding the Tx\_Ref\_Triggers. Note that this is usually not the number of Tx\_Trigger memory elements; the number of basic cycles in the system matrix and the trigger's repeat factors have to be taken into account. An inaccurate configuration of **TTMLM.ENTT** will result in either a Tx Count Underflow (**TTIR.TXU** = '1' and **TTOST.EL** = "01", severity 1) or in a Tx Count Overflow (**TTIR.TXO** = '1' and **TTOST.EL** = "10", severity 2).

**Note:** *In case the first reference message seen by a node does not have Cycle\_Count zero, this node may finish its first matrix cycle with its Tx count resulting in a Tx Count Underflow condition. As long as a node is in state Synchronizing its Tx\_Triggers will not lead to transmissions.*

**TTMLM.CCM** specifies the number of the last basic cycle in the system matrix. The counting of basic cycles starts at 0. In a system matrix consisting of 8 basic cycles **TTMLM.CCM** would be 7. **TTMLM.CCM** is ignored by time slaves, a receiver of a reference message considers the received cycle count as the valid cycle count for the actual basic cycle.

**TTMLM.TXEW** specifies the length of the Tx enable window in NTUs. The Tx enable window is that period of time at the beginning of a time window where a transmission may be started. If a transmission of a message cannot be started inside the Tx enable window because of e.g. a slight overlap from the previous time window's message, the transmission cannot be started in that time window at all. **TTMLM.TXEW** has to be chosen with respect to the network's synchronisation quality and with respect to the relation between the length of the time windows and the length of the messages.

### 4.2.3 Trigger Memory

The trigger memory is part of the external Message RAM to which the M\_TTCAN is connected via its Generic Master Interface (see Figure 2). It stores up to 64 trigger elements. A trigger memory element consists of Time Mark **TM**, Cycle Code **CC**, Trigger Type **TYPE**, Filter Type **FTYPE**, Message Number **MNR**, Message Status Count **MSC**, Time Mark Event Internal **TMIN**, Time Mark Event External **TMEX**, and Asynchronous Serial Communication **ASC** (see Section 2.4.7).

The time mark defines at which cycle time a trigger becomes active. The triggers in the trigger memory have to be sorted by their time marks. The trigger element with the lowest time mark is written to the first trigger memory word. Message number and cycle code are ignored for triggers of type Tx\_Ref\_Trigger, Tx\_Ref\_Trigger\_Gap, Watch\_Trigger, Watch\_Trigger\_Gap, and End\_of\_List.

When the cycle time reaches the time mark of the actual trigger, the FSE switches to the next trigger and starts to read the following trigger from the trigger memory. In case of a transmit trigger, the Tx Handler starts to read the message from the Message RAM as soon as the FSE switches to its trigger. The RAM access speed defines the minimum time step between a transmit trigger and its preceding trigger, the Tx Handler has to be able to prepare the transmission before the transmit trigger's time mark is reached. The RAM access speed also limits the number of non-matching (with regard to their cycle code) triggers between two matching triggers, the next matching trigger must be read before its time mark is reached. If the reference message is n NTU long, a trigger with a time mark < n will never become active and will be treated as a configuration error.

Starting point of the cycle time is the sample point of the reference message's start of frame bit. The next reference message is requested when cycle time reaches the Tx\_Ref\_Trigger's time mark. The M\_TTCAN reacts on the transmission request at the next sample point. A new Sync\_Mark is captured at the start of frame bit, but the cycle time is incremented until the reference message is successfully transmitted (or received) and the Sync\_Mark is taken as the new Ref\_Mark. At that point in time, cycle time is restarted. As a consequence, cycle time can never (with the exception of initialisation) be seen at a value < n, with n being the length of the reference message measured in NTU.

Length of a basic cycle: Tx\_Ref\_Trigger's time mark + 1 NTU + 1 CAN bit time

The trigger list will be different for all nodes in the TTCAN network. Each node knows only the Tx\_Triggers for its own transmit messages, the Rx\_Triggers for those receive messages that are processed by this node, and the triggers concerning the reference messages.

#### 4.2.3.1 Trigger Types

Tx\_Ref\_Trigger (**TYPE** = "0000") and Tx\_Ref\_Trigger\_Gap (**TYPE** = "0001") cause the transmission of a reference message by a time master. A configuration error (**TTOST.EL** = "11", severity 3) is detected when a time slave encounters a Tx\_Ref\_Trigger(\_Gap) in its trigger memory. Tx\_Ref\_Trigger\_Gap is only used in external event-synchronised time-triggered operation mode. In that mode, Tx\_Ref\_Trigger is ignored when the M\_TTCAN synchronisation state is In\_Gap (**TTOST.SYS** = "10").

Tx\_Trigger\_Single (**TYPE** = "0010"), Tx\_Trigger\_Continuous (**TYPE** = "0011"), Tx\_Trigger\_Arbitration (**TYPE** = "0100"), and Tx\_Trigger\_Merged (**TYPE** = "0101") cause the start of a transmission. They define the start of a time window.

Tx\_Trigger\_Single starts a single transmission in an exclusive time window when the message buffer's Transmission Request Pending bit is set. After successful transmission the Transmission Request Pending bit is reset.

Tx\_Trigger\_Continuous starts a transmission in an exclusive time window when the message buffer's Transmission Request Pending bit is set. After successful transmission the Transmission Request Pending bit remains set, and the message buffer is transmitted again in the next matching time window.

Tx\_Trigger\_Arbitration starts an arbitrating time window, Tx\_Trigger\_Merged a merged arbitrating time window. The last Tx\_Trigger of a merged arbitrating time window must be of type Tx\_Trigger\_Arbitration. A Configuration Error (**TTOST.EL** = "11", severity 3) is detected when a trigger of type Tx\_Trigger\_Merged is followed by any other Tx\_Trigger than one of type Tx\_Trigger\_Merged or Tx\_Trigger\_Arbitration. Several Tx\_Triggers may be defined for the same Tx message buffer. Depending on their cycle code, they may be ignored in some basic cycles. The cycle code has to be considered when the expected number of Tx\_Triggers (**TTMLM.ENTT**) is calculated.

Watch\_Trigger (**TYPE** = "0110") and Watch\_Trigger\_Gap (**TYPE** = "0111") check for missing reference messages. They are used by both time masters and time slaves. Watch\_Trigger\_Gap is only used in external event-synchronized time-triggered operation mode. In that mode, a Watch\_Trigger is ignored when the M\_TTCAN synchronisation state is In\_Gap (**TTOST.SYS** = "10").

Rx\_Trigger (**TYPE** = "1000") is used to check for the reception of periodic messages in exclusive time windows. Rx\_Triggers are not active until state In\_Schedule or In\_Gap is reached. The time mark of an Rx\_Trigger shall be placed after the end of that message's transmission, independent of time window boundaries. Depending on their cycle code, Rx\_Triggers may be ignored in some basic cycles. At the time mark of the Rx\_Trigger, it is checked whether the last received message before this time mark and after start of cycle or previous Rx\_Trigger had matched the acceptance filter element referenced by **MNR**. Accepted messages are stored in one of the two receive FIFOs, according to the acceptance filtering, independent of the Rx\_Trigger. Acceptance filter elements which are referenced by Rx\_Triggers should be placed at the beginning of the filter list to ensure that the filtering is finished before the Rx\_Trigger's time mark is reached.

Time\_Base\_Trigger (**TYPE** = "1001") are used to generate internal/external events depending on the configuration of **ASC**, **TMIN**, and **TMAX**.

End\_of\_List (**TYPE** = "1010...1111") is an illegal trigger type, a configuration error (**TTOST.EL** = "11", severity 3) is detected when an End\_of\_List trigger is encountered in the trigger memory before the Watch\_Trigger or Watch\_Trigger\_Gap.

#### 4.2.3.2 Restrictions for the Node's Trigger List

There may not be two triggers that are active at the same cycle time and cycle count, but triggers that are active in different basic cycles (different cycle code) may share the same time mark.

Rx\_Triggers and Time\_Base\_Triggers may not be placed inside the Tx enable windows of Tx\_Trigger\_Single/Continuous/Arbitration, but they may be placed after Tx\_Trigger\_Merged or Tx\_Ref\_Trigger.

Triggers that are placed after the Watch\_Trigger (or the Watch\_Trigger\_Gap when **TTOST.SYS** = "10") will never become active. The watch triggers themselves will not become active when the reference messages are transmitted on time.

All unused trigger memory words (after the Watch\_Trigger or after the Watch\_Trigger\_Gap when **TTOST.SYS** = "10") must be set to trigger type End\_of\_List.

A typical trigger list for a potential time master will begin with a number of Tx\_Triggers and Rx\_Triggers followed by the Tx\_Ref\_Trigger and the Watch\_Trigger. For networks with external event- synchronized time-triggered communication, this is followed by the Tx\_Ref\_Trigger\_Gap and the Watch\_Trigger\_Gap. The trigger list for a time slave will be the same but without the Tx\_Ref\_Trigger and the Tx\_Ref\_Trigger\_Gap.

At the beginning of each basic cycle, that is at each reception or transmission of a reference message, the trigger list is processed starting with the first trigger memory element. The FSE looks for the first trigger with a cycle code that matches the current cycle count. The FSE waits until cycle time reaches the trigger's time mark and activates the trigger. Afterwards the FSE looks for the next trigger in the list with a cycle code that matches the current cycle count.

Special consideration is needed for the time around Tx\_Ref\_Trigger and Tx\_Ref\_Trigger\_Gap. In a time master competing for master ship, the effective time mark of a Tx\_Ref\_Trigger may be decremented in order to be the first node to start a reference message. In backup time masters the effective time mark of a Tx\_Ref\_Trigger or Tx\_Ref\_Trigger\_Gap is the sum of its configured time mark and the Reference Trigger Offset **TTOCF.IRTO**. In case error level 2 is reached (**TTOST.EL** = "10"), the effective time mark is the sum of its time mark and 0x127. No other trigger elements should be placed in this range otherwise it may happen, that the time marks appear out of order and are flagged as a configuration error. Trigger elements which are coming after Tx\_Ref\_Trigger may never become active as long as the reference messages come in time.

There are interdependencies between the following parameters:

- Host clock frequency
- Speed and waiting time for Trigger RAM accesses
- Length of the acceptance filter list
- Number of trigger elements
- Complexity of cycle code filtering in the trigger elements
- Offset between time marks of the trigger elements

### 4.2.3.3 Example for Trigger Handling

The example below shows how the trigger list is derived from a node's system matrix. Assumed node A is first time master and has knowledge of the section of the system matrix shown in Table 65 below.

Cycle Count	Time Mark1	Time Mark2	Time Mark3	Time Mark4	Time Mark5	Time Mark6	Time Mark7
0	Tx7					TxRef	Error
1	Rx3		Tx2, Tx4			TxRef	Error
2						TxRef	Error
3	Tx7		Rx5			TxRef	Error
4	Tx7			Rx6		TxRef	Error

Table 69 System Matrix Node A

The cycle count starts with 0 and runs until 0, 1, 3, 7, 15, 31, 63 (the number of basic cycles in the system matrix is 1, 2, 4, 8, 16, 32, 64). The maximum cycle count is configured by **TTMLM.CCM**. The Cycle Code **CC** is composed of repeat factor (= value of most significant '1') and the number of the first basic cycle in the system matrix (= bit field after most significant '1').

Example: with a cycle code of 0b0010011 (repeat factor: 16, first basic cycle: 3) and a maximum cycle count of **TTMLM.CCM** = "0x3F" matches occur at cycle counts 3, 19, 35, 51

A trigger element consists of Time Mark **TM**, Cycle Code **CC**, Trigger Type **TYPE**, and Message Number **MNR**. For transmission **MNR** references the Tx Buffer number (0..31). For reception **MNR** references the number of the filter element (0..127) that matched during acceptance filtering. Depending on the configuration of the Filter Type **FTYPE**, the 11-bit or 29-bit message ID filter list is referenced.

In addition a trigger element can be configured for Asynchronous Serial Communication **ASC**, generation of Time Mark Event Internal **TMIN**, and Time Mark Event External **TMEX**. The Message Status Count **MSC** holds the counter value (0..7) for scheduling errors for periodic messages in exclusive time windows at the point in time when the time mark of the trigger element became active.

Trigger	Time Mark TM[15:0]	Cycle Code CC[6:0]	Trigger Type TYPE[3:0]	Mess. No. MNR[6:0]
0	Mark1	0b0000100	Tx_Trigger_Single	7
1	Mark1	0b1000000	Rx_Trigger	3
2	Mark1	0b1000011	Tx_Trigger_Single	7
3	Mark3	0b1000001	Tx_Trigger_Merged	2
4	Mark3	0b1000011	Rx_Trigger	5
5	Mark4	0b1000001	Tx_Trigger_Arbitration	4
6	Mark4	0b1000100	Rx_Trigger	6
7	Mark6	n.a.	Tx_Ref_Trigger	0 (Ref)
8	Mark7	n.a.	Watch_Trigger	n.a.
9	n.a.	n.a.	End_of_List	n.a.

Table 70 Trigger List Node A

Tx\_Trigger\_Single, Tx\_Trigger\_Continuous, Tx\_Trigger\_Merged, Tx\_Trigger\_Arbitration, Rx\_Trigger, and Time\_Base\_Trigger are only valid for the specified cycle code. For all other trigger types the cycle code is ignored.

The FSE starts the basic cycle with scanning the trigger list starting from zero until a trigger with time mark > cycle time and with its Cycle Code **CC** matching the actual cycle count is reached, or a trigger of type Tx\_Ref\_Trigger, Tx\_Ref\_Trigger\_Gap, Watch\_Trigger, or Watch\_Trigger\_Gap is encountered.

When the cycle time reached the Time Mark **TM**, the action defined by Trigger Type **TYPE** and Message Number **MNR** is started. There is an error in the configuration when End\_of\_List is reached.

At Mark6 the reference message (always TxRef) is transmitted. After transmission of the reference message the FSE returns to the beginning of the trigger list. When the Watch Trigger at Mark7 is reached, the node was not able to transmit the reference message; error treatment is started.

#### 4.2.3.4 Detection of Configuration Errors

A configuration error is signalled via **TTOST.EL** = "11" (severity 3) when:

The FSE comes to a trigger in the list with a cycle code that matches the current cycle count but with a time mark that is less than the cycle time.

The previous active trigger was a Tx\_Trigger\_Merged and the FSE comes to a trigger in the list with a cycle code that matches the current cycle count but that is neither a Tx\_Trigger\_Merged nor a Tx\_Trigger\_Arbitration nor a Time\_Base\_Trigger nor an Rx\_Trigger.

The FSE of a node with **TTOCF.TM**='0' (time slave) encounters a Tx\_Ref\_Trigger or a Tx\_Ref\_Trigger\_Gap.

Any time mark placed inside the Tx enable window (defined by **TTMLM.TXEW**) of a Tx\_Trigger with a matching cycle code.

A time mark is placed near the time mark of a Tx\_Ref\_Trigger and the Reference Trigger Offset **TTOST.RTO** causes a reversal of their sequential order measured in cycle time.

#### 4.2.4 TTCAN Schedule Initialization

The synchronisation to the M\_TTCAN's message schedule starts when **CCCR.INIT** is reset. The M\_TTCAN can operate strictly time-triggered (**TTOCF.GEN** = '0') or external event-synchronized time-triggered (**TTOCF.GEN** = '1'). All nodes start with cycle time zero at the beginning of their trigger list with **TTOST.SYS** = "00" (out of synchronisation), no transmission is enabled with the exception of the reference message. Nodes in external event-synchronised time-triggered operation mode will ignore Tx\_Ref\_Trigger and Watch\_Trigger and will use instead Tx\_Ref\_Trigger\_Gap and Watch\_Trigger\_Gap until the first reference message decides whether a Gap is active.

##### 4.2.4.1 Time Slaves

After configuration, a time slave will ignore its Watch\_Trigger and Watch\_Trigger\_Gap when it did not receive any message before reaching the Watch\_Triggers. When it reaches Init\_Watch\_Trigger, interrupt flag **TTIR.IWT** is set, the FSE is frozen, and the cycle time will become invalid, but the node will still be able to take part in CAN bus communication (to give acknowledge or to send error flags). The first received reference message will restart the FSE and the cycle time.

**Note: Init\_Watch\_Trigger is not part of the trigger list. It is implemented as an internal counter which counts up to 0xFFFF = maximum cycle time.**

When a time slave has received any message but the reference message before reaching the Watch\_Triggers, it will assume a fatal error (**TTOST.EL** = "11", severity 3), set interrupt flag **TTIR.WT**, switch off its CAN bus output, and enter the bus monitoring mode (**CCCR.MON** set to '1'). In the bus monitoring mode it is still able to receive messages, but it cannot send any dominant bits and therefore cannot give acknowledge.

**Note: To leave the fatal error state, the Host has to set CCCR.INIT = '1'. After reset of CCCR.INIT, the node restarts TTCAN communication.**

When no error is encountered during synchronisation, the first reference message sets **TTOST.SYS** = "01" (Synchronizing), the second sets the TTCAN synchronization state (depending on its **Next\_is\_Gap** bit) to **TTOST.SYS** = "11" (In\_Schedule) or **TTOST.SYS** = "10" (In\_Gap), enabling all Tx\_Triggers and Rx\_Triggers.

#### 4.2.4.2 Potential Time Masters

After configuration, a potential time master will start the transmission of a reference message when it reaches its Tx\_Ref\_Trigger (or its Tx\_Ref\_Trigger\_Gap when in external event-synchronized time-triggered operation). It will ignore its Watch\_Trigger and Watch\_Trigger\_Gap when it did not receive any message or transmit the reference message successfully before reaching the Watch\_Triggers (assumed reason: all other nodes still in reset or configuration, giving no acknowledge). When it reaches Init\_Watch\_Trigger, the attempted transmission is aborted, interrupt flag **TTIR.IWT** is set, the FSE is frozen, and the cycle time will become invalid, but the node will still be able to take part in CAN bus communication (to give acknowledge or to send error flags). Resetting **TTIR.IWT** will re-enable the transmission of reference messages until next time the Init\_Watch\_Trigger condition is met, or another CAN message is received. The FSE will be restarted by the reception of a reference message.

When a potential time master reaches the Watch\_Triggers after it has received any message but the reference message, it will assume a fatal error (**TTOST.EL** = "11", severity 3), set interrupt flag **TTIR.WT**, switch off its CAN bus output, and enter the bus monitoring mode (**CCCR.MON** set to '1'). In bus monitoring mode, it is still able to receive messages, but it cannot send any dominant bits and therefore cannot give acknowledge.

When no error is detected during initialization, the first reference message sets **TTOST.SYS** = "01" (synchronizing), the second sets the TTCAN synchronization state (depending on its **Next\_is\_Gap** bit) to **TTOST.SYS** = "11" (In\_Schedule) or **TTOST.SYS** = "10" (In\_Gap), enabling all Tx\_Triggers and Rx\_Triggers.

A potential time master is current time master (**TTOST.MS** = "11") when it was the transmitter of the last reference message, else it is backup time master (**TTOST.MS** = "10").

When all potential time masters have finished configuration, the node with the highest time master priority in the network will become the current time master.

### 4.3 TTCAN Gap Control

All functions related to Gap control apply only when the M\_TTCAN is operated in external event-synchronized time-triggered mode (**TTOCF.GEN** = '1'). In this operation mode the TTCAN message schedule may be interrupted by inserting Gaps between the basic cycles of the system matrix. All nodes connected to the CAN network have to be configured for external event-synchronized time-triggered operation.

During a Gap, all transmissions are stopped and the CAN bus remains idle. A Gap is finished when the next reference message starts a new basic cycle. A Gap starts at the end of a basic cycle that itself was started by a reference message with bit **Next\_is\_Gap** = '1' e.g. Gaps are initiated by the current time master.

The current time master has two options to initiate a Gap. A Gap can be initiated under software control when the application program writes **TTOCN.NIG** = '1'. The **Next\_is\_Gap** bit will be transmitted as '1' with the next reference message. A Gap can also be initiated under hardware control when the application program enables the event trigger input pin **m\_ttcan\_evt** by writing **TTOCN.GCS** = '1'. When a reference message is started and **TTOCN.GCS** is set, a HIGH level at pin **m\_ttcan\_evt** will set **Next\_is\_Gap** = '1'.

As soon as that reference message is completed, the **TTOST.WFE** bit will announce the Gap to the time master as well as to the time slaves. The current basic cycle will continue until its last time window. The time after the last time window is the Gap time.

For the actual time master and the potential time masters, **TTOST.GSI** will be set when the last basic cycle has finished and the Gap time starts. In nodes that are time slaves, bit **TTOST.GSI** will remain at '0'.

When a potential time master is in synchronization state `In_Gap` (**TTOST.SYS** = "10"), it has four options to intentionally finish a Gap:

Under software control by writing **TTOCN.FGP** = '1'.

Under hardware control (**TTOCN.GCS** = '1') an edge from HIGH to LOW at the event-trigger input pin `m_ttcn_evt` sets **TTOCN.FGP** and restarts the schedule.

The third option is a time-triggered restart. When **TTOCN.TMG** = '1', the next register time mark interrupt (**TTIR.RTMI** = '1') will set **TTOCN.FGP** and start the reference message.

Finally any potential time master will finish a Gap when it reaches its `Tx_Ref_Trigger_Gap`, assuming that the event to synchronize on did not occur in time.

Neither of these options can cause a basic cycle to be interrupted with a reference message.

Setting of **TTOCN.FGP** after the Gap time has started will start the transmission of a reference message immediately and will thereby synchronize the message schedule. When **TTOCN.FGP** is set before the Gap time has started (while the basic cycle is still in progress), the next reference message is started at the end of the basic cycle, at the `Tx_Ref_Trigger` – there will be no Gap time in the message schedule.

In strictly time-triggered operation, bit **Next\_is\_Gap** = '1' in the reference message will be ignored, as well as the event-trigger input pin `m_ttcn_evt` and the bits **TTOCN.NIG**, **TTOCN.FGP**, and **TTOCN.TMG**.

## 4.4 Stop Watch

The stop watch function enables capturing of M\_TTCAN internal time values (local time, cycle time, or global time) triggered by an external event.

To enable the stop watch function, the application program first has to define local time, cycle time, or global time as stop watch source via **TTOCN.SWS**. When **TTOCN.SWS** is  $\neq$  "00" and TT Interrupt Register flag **TTIR.SWE** is '0', the actual value of the time selected by **TTOCN.SWS** will be copied into **TTCPT.SWV** on the next rising/falling edge (as configured via **TTOCN.SWP**) on pin **m\_ttcn\_swf**. This will set interrupt flag **TTIR.SWE**. After the application program has read **TTCPT.SWV**, it may enable the next stop watch event by resetting **TTIR.SWE** to '0'.

## 4.5 Local Time, Cycle Time, Global Time, and External Clock Synchronization

There are two possible levels in time-triggered CAN: Level 1 and Level 2. Level 1 only provides time-triggered operation using cycle time. Level 2 additionally provides increased synchronisation quality, global time and external clock synchronisation. In both levels, all timing features are based on a local time base - the local time.

The local time is a 16-bit cyclic counter, it is incremented once each NTU. Internally the NTU is represented by a 3-bit counter which can be regarded as a fractional part (three binary digits) of the local time. Generally, the 3-bit NTU counter is incremented 8 times each NTU. If the length of the NTU is shorter than 8 CAN clock periods (as may be configured in Level 1, or as a result of clock calibration in Level 2), the length of the NTU fraction is adapted, and the NTU counter is incremented only 4 times each NTU.

Figure 9 describes the synchronisation of the cycle time and global time, performed in the same manner by all TTCAN nodes, including the time master. Any message received or transmitted invokes a capture of the local time taken at the message's frame synchronisation event. This frame synchronisation event occurs at the sample point of each Start of Frame (SoF) bit and causes the local time to be stored as Sync\_Mark. Sync\_Marks and Ref\_Marks are captured including the 3-bit fractional part.

Whenever a valid reference message is transmitted or received, the internal Ref\_Mark is updated from the Sync\_Mark. The difference between Ref\_Mark and Sync\_Mark is the Cycle Sync Mark (Cycle Sync Mark = Sync\_Mark - Ref\_Mark) stored in register **TTCSM**. The most significant 16 bits of the difference between Ref\_Mark and the actual value of the local time is the cycle time (Cycle Time = Local Time - Ref\_Mark).

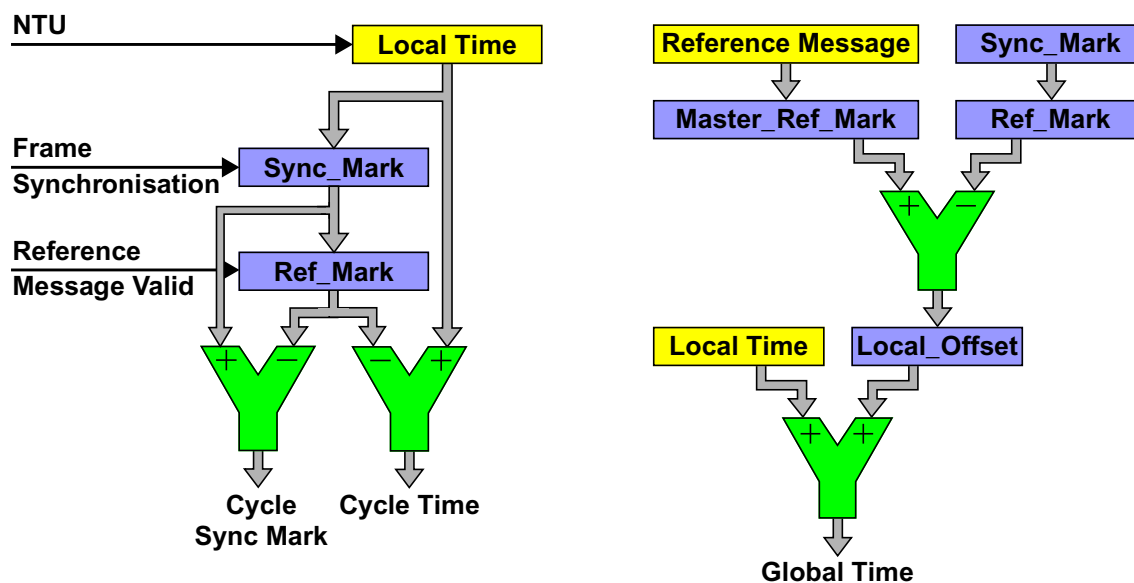

Figure 9 Cycle Time and Global Time Synchronization

The cycle time that can be read from **TTCTC.CT** is the difference of the node's local time and Ref\_Mark, both synchronized into the Host clock domain and truncated to 16 bit.

The global time exists for TTCAN Level 0 and Level 2 only, in Level 1 it is invalid. The node's view of the global time is the local image of the global time in (local) NTUs. After configuration, a potential time master will use its own local time as global time. The time master establishes its own local time as global time by transmitting its own Ref\_Marks as Master\_Ref\_Marks in the reference message (bytes 3,4). The global time that can be read from **TTLGT.GT** is the sum of the node's local time and its local offset, both synchronized into the Host clock domain and truncated to 16 bit. The fractional part is used for clock synchronization only.

A node that receives a reference message calculates its local offset to the global time by comparing its local Ref\_Mark with the received Master\_Ref\_Mark (see Figure 9). The node's view of the global time is local time + local offset. In a potential time master that has never received another time master's reference message, Local\_Offset will be zero. When a node becomes the current time master after first having received other reference messages, Local\_Offset will be frozen at its last value. In the time receiving nodes, Local\_Offset may be subject to small adjustments, due to clock drift, when another node becomes time master, or when there is a global time discontinuity, signalled by **Disc\_Bit** in the reference message. With the exception of global time discontinuity, the global time provided to the application program by register **TTLGT** is smoothed by a low-pass filtering to have a continuous monotonic value.

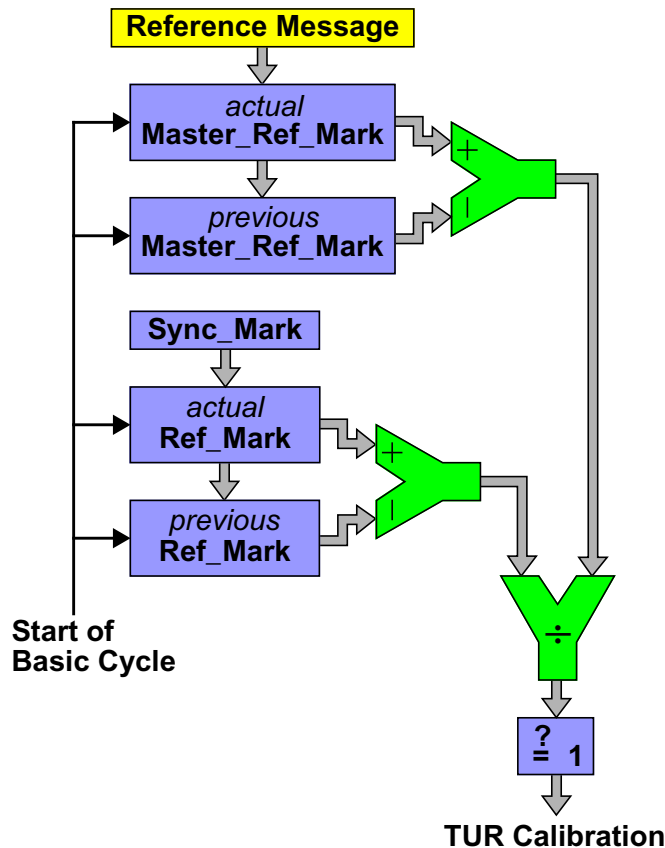

Figure 10 TTCAN Level 0 and Level 2 Drift Compensation

Figure 10 describes how in TTCAN Level 0,2 each time receiving node compensates the drift between its own local clock and the time master's clock by comparing the length of a basic cycle in local time and in global time. If there is a difference between the two values and the **Disc\_Bit** in the reference message is not set, a new value for **TURNA.NAV** is calculated. If the Synchronisation Deviation  $SD = |NC - TURNA.NAV| \leq SDL$  (Synchronisation Deviation Limit), the new value for **TURNA.NAV** takes effect. Else the automatic drift compensation is suspended.

In TTCAN Level 0 and Level 2, **TTOST.QCS** indicates whether the automatic drift compensation is active or suspended. In TTCAN Level 1, **TTOST.QCS** is always '1'.

The current time master may synchronize its local clock speed and the global time phase to an external clock source. This is enabled by bit **TTOCF.EECS**.

The stop watch function (see Section 4.4) may be used to measure the difference in clock speed between the local clock and the external clock. The local clock speed is adjusted by first writing the newly calculated Numerator Configuration Low to **TURCF.NCL** (**TURCF.DC** cannot be updated during operation). The new value takes effect by writing **TTOCN.ECS** to '1'.

The global time phase is adjusted by first writing the phase offset into the TT Global Time Preset register **TTGTP**. The new value takes effect by writing **TTOCN.SGT** to '1'. The first reference message transmitted after the global time phase adjustment will have the **Disc\_Bit** set to '1'.

**TTOST.QGTP** shows whether the node's global time is in phase with the time master's global time. **TTOST.QGTP** is permanently '0' in TTCAN Level 1 and when the Synchronisation Deviation Limit is exceeded in TTCAN Level 0,2 (**TTOST.QCS** = '0'). It is temporarily '0' while the global time is low-pass filtered to supply the application with a continuous monotonic value. There is no low-pass filtering when the last reference message contained a **Disc\_Bit** = '1' or when **TTOST.QCS** = '0'.

## 4.6 TTCAN Error Level

The ISO 11898-4 specifies four levels of error severity:

S0 - No Error

S1 - Warning

Only notification of application, reaction application-specific.

S2 Error

Notification of application. All transmissions in exclusive or arbitrating time windows are disabled (i.e. no data or remote frames may be started). Potential time masters still transmit reference messages with the Reference Trigger Offset **TTOST.RTO** set to the maximum value of 127.

S3 - Severe Error

Notification of application. All CAN bus operations are stopped, i.e. transmission of dominant bits is not allowed, and **CCCR.MON** is set. The S3 error condition remains active until the application updates the configuration (set **CCCR.CCE**).

If several errors are detected at the same time, the highest severity prevails. When an error is detected, the application is notified by **TTIR.ELC**. The error level is monitored by **TTOST.EL**.

The M\_TTCAN signals the following error conditions as required by ISO 11898-4:

### Config\_Error (S3)

Sets Error Level **TTOST.EL** to "11" when a merged arbitrating time window is not properly closed or when there is a Tx\_Trigger with a time mark beyond the Tx\_Ref\_Trigger.

### Watch\_Trigger\_Reached (S3)

Sets Error Level **TTOST.EL** to "11" when a watch trigger was reached because the reference message is missing.

### Application\_Watchdog (S3)

Sets Error Level **TTOST.EL** to "11" when the application failed to serve the application watchdog. The application watchdog is configured via **TTOCF.AWL**. It is served by reading register **TTOST**. When the watchdog is not served in time, bit **TTOST.AWE** and interrupt flag **TTIR.AW** are set, all TTCAN communication is stopped, and the M\_TTCAN is set into bus monitoring mode (**CCCR.MON** set to '1').

### CAN\_Bus\_Off (S3)

Entering **CAN\_Bus\_Off** state sets error level **TTOST.EL** to "11". **CAN\_Bus\_Off** state is signalled by **PSR.BO** = '1' and **CCCR.INIT** = '1'.

**Scheduling\_Error\_2 (S2)**

Sets Error Level **TTOST.EL** to "10" if the MSC of one Tx\_Trigger has reached 7. In addition interrupt flag **TTIR.SE2** is set. The Error Level **TTOST.EL** is reset to "00" at the beginning of a matrix cycle when no Tx\_Trigger has an MSC of 7 in the preceding matrix cycle.

**Tx\_Overflow (S2)**

Sets Error Level **TTOST.EL** to "10" when the Tx count is equal or higher than the expected number of Tx\_Triggers **TTMLM.ENTT** and a Tx\_Trigger event occurs. In addition interrupt flag **TTIR.TXO** is set. The Error Level **TTOST.EL** is reset to "00" when the Tx count is no more than **TTMLM.ENTT** at the start of a new matrix cycle.

**Scheduling\_Error\_1 (S1)**

Sets Error Level **TTOST.EL** to "01" if within one matrix cycle the difference between the maximum MSC and the minimum MSC for all trigger memory elements (of exclusive time windows) is larger than 2, or if one of the MSCs of an exclusive Rx\_Trigger has reached 7. In addition interrupt flag **TTIR.SE1** is set. If within one matrix cycle none of these conditions is valid, the Error Level **TTOST.EL** is reset to "00".

**Tx\_Underflow (S1)**

Sets Error Level **TTOST.EL** to "01" when the Tx count is less than the expected number of Tx\_Triggers **TTMLM.ENTT** at the start of a new matrix cycle. In addition interrupt flag **TTIR.TXU** is set. The Error Level **TTOST.EL** is reset to "00" when the Tx count is at least **TTMLM.ENTT** at the start of a new matrix cycle.

**4.7 TTCAN Message Handling****4.7.1 Reference Message**

For potential time masters the identifier of the reference message is configured via **TTRMC.RID**. No dedicated Tx Buffer is required for transmission of the reference message. When a reference message is transmitted, the first data byte (TTCAN Level 1) resp. the first four data bytes (TTCAN Level 0 and Level 2) will be provided by the FSE.

In case the reference message Payload Select **TTRMC.RMPS** is set, the rest of the reference message's payload (Level 1: bytes 2-8, Level 0,2: bytes 5-6) is taken from Tx Buffer 0. In this case the data length **DLC** code from message buffer 0 is used.

<b>TTRMC.RMPS</b>	<b>TXBRP.TRP0</b>	<b>Level 0</b>	<b>Level 1</b>	<b>Level 2</b>
0	0	4	1	4
0	1	4	1	4
1	0	4	1	4
1	1	4 + MB0	1 + MB0	4 + MB0

Table 71 Number of Data Bytes transmitted with a reference messages

To send additional payload with the reference message in Level 1 a **DLC > 1** has to be configured, for Level 0,2 a **DLC > 4** is required. In addition the transmission request pending bit **TXBRP.TRP0** of message buffer 0 must be set (see Table 71). In case bit **TXBRP.TRP0** is not set when a reference message is started, the reference message is transmitted with the data bytes supplied by the FSE only.

For acceptance filtering of reference messages the Reference Identifier **TTRMC.RID** is used.

**4.7.2 Message Reception**

Message reception is done via the two Rx FIFOs in the same way as for event-driven CAN communication (see Section 3.4).

The Message Status Count **MSC** is part of the corresponding trigger memory element and has to be initialized to zero during configuration. It is updated while the M\_TTCAN is in synchronization states In\_Gap or In\_Schedule. The update happens at the message's Rx\_Trigger. At this point in time it is checked at which acceptance filter element the latest message received in this basic cycle had matched. The matching filter number is stored as the acceptance filter result. If this is the same the filter number as defined in this trigger memory element, the **MSC** is decremented by one. If the acceptance filter result is not the same filter number as defined for this filter element, or if the acceptance filter result is cleared, the **MSC** is incremented by one. At each Rx\_Trigger and at each start of cycle, the last acceptance filter result is cleared.

The time mark of an Rx\_Trigger should be set to a value where it is ensured that reception and acceptance filtering for the targeted message has completed. This has to take into consideration the RAM access time and the order of the filter list. It is recommended, that filters which are used for Rx\_Triggers are placed at the beginning of the filter list. It is not recommended to use an Rx\_Trigger for the reference message.

### 4.7.3 Message Transmission

For time-triggered message transmission the M\_TTCAN supplies 32 dedicated Tx buffers (see Section 3.5.1). A Tx FIFO or Tx queue is not available when the M\_TTCAN is configured for time-triggered operation (**TTOCF.OM** = "01" or "10").

Each Tx\_Trigger in the trigger memory points to a particular Tx buffer containing a specific message. There may be more than one Tx\_Trigger for a given Tx buffer if that Tx buffer contains a message that is to be transmitted more than once in a basic cycle or matrix cycle.

The application program has to update the data regularly and on time, synchronized to the cycle time. The Host CPU is responsible that no partially updated messages are transmitted. To assure this the Host has to proceed in the following way:

Tx\_Trigger\_Single / Tx\_Trigger\_Merged / Tx\_Trigger\_Arbitration

- Check whether the previous transmission has completed by reading **TXBTO**
- Update the Tx buffer's configuration and/or payload
- Issue an Add Request to set the Tx Buffer Request Pending bit

Tx\_Trigger\_Continuous

- Issue a Cancellation Request to reset the Tx Buffer Request Pending bit
- Check whether the cancellation has finished by reading **TXBCF**
- Update Tx buffer's configuration and/or payload
- Issue an Add Request to set the Tx Buffer Request Pending bit

The message's **MSC** stored with the corresponding Tx\_Trigger provides information on the success of the transmission.

The **MSC** is incremented by one when the transmission could not be started because the CAN bus was not idle within the corresponding transmit enable window or when the message was started and could not be completed successfully. The **MSC** is decremented by one when the message was transmitted successfully or when the message could have been started within its transmit enable window but was not started because transmission was disabled (M\_TTCAN in Error Level S2 or Host has disabled this particular message).

The Tx buffers may be managed dynamically, i.e. several messages with different identifiers may share the same Tx buffer element. In this case the Host has to assure that no transmission request is pending for the Tx buffer element to be reconfigured by checking **TXBRP**.

If a Tx buffer with pending transmission request should be updated, the Host first has to issue a cancellation request and check whether the cancellation has completed by reading **TXBCF** before it starts updating.

The Tx Handler will transfer a message from the Message RAM to its intermediate output buffer at the trigger element which becomes active immediately before the Tx\_Trigger element which defines the beginning of the transmit window. During and after the transfer time the transmit message may not be updated and its **TXBRP** bit may not be changed. To control this transfer time, an additional trigger element may be placed before the Tx\_Trigger. This may be e.g. a Time\_Base\_Trigger which need not cause any other action. The difference in time marks between the Tx\_Trigger and the preceding trigger has to be large enough to guarantee that the Tx Handler can read four words from the Message RAM even at high RAM access load from other modules.

#### 4.7.3.1 *Transmission in Exclusive Time Windows*

A transmission is started time-triggered when the cycle time reaches the time mark of a Tx\_Trigger\_Single or Tx\_Trigger\_Continuous. There is no arbitration on the bus with messages from other nodes. The **MSC** is updated according the result of the transmission attempt. After successful transmission started by a Tx\_Trigger\_Single the respective Tx Buffer Request Pending bit is reset. After successful transmission started by a Tx\_Trigger\_Continuous the respective Tx Buffer Request Pending remains set. When the transmission was not successful due to disturbances, it will be repeated next time (one of) its Tx\_Trigger(s) become(s) active.

#### 4.7.3.2 *Transmission in Arbitrating Time Windows*

A transmission is started time-triggered when the cycle time reaches the time mark of a Tx\_Trigger\_Arbitration. Several nodes may start to transmit at the same time. In this case the message has to arbitrate with the messages from other nodes. The **MSC** is not updated. When the transmission was not successful (lost arbitration or disturbance), it will be repeated next time (one of) its Tx\_Trigger(s) become(s) active.

#### 4.7.3.3 *Transmission in Merged Arbitrating Time Windows*

The purpose of a merged arbitrating time window is to enable multiple nodes to send a limited number of frames which are transmitted in immediate sequence, the order given by CAN arbitration. It is not intended for burst transmission by a single node. Since the node does not have exclusive access within this time window, it may happen that not all requested transmissions are successful.

Messages which have lost arbitration or were disturbed by an error, may be re-transmitted inside the same merged arbitrating time window. The re-transmission will not be started if the corresponding Transmission Request Pending flag was reset by a successful Tx cancellation.

In single transmit windows, the Tx Handler transmits the message indicated by the message number of the trigger element. In merged arbitrating time windows, it can handle up to three message numbers from the trigger list. Their transmissions will be attempted in the sequence defined by the trigger list. If the time mark of a fourth message is reached before the first is transmitted (or cancelled by the Host), the fourth request will be ignored.

The transmission inside a merged arbitrating time window is not time-triggered. The transmission of a message may start before its time mark, or after the time mark if the bus was not idle.

The messages transmitted by a specific node inside a merged arbitrating time window will be started in the order of their Tx\_Triggers, so a message with low CAN priority may prevent the successful transmission of a following message with higher priority, if there is compelling bus traffic. This has to be considered for the configuration of the trigger list. Time\_Base\_Triggers may be placed between consecutive Tx\_Triggers to define the time until the data of the corresponding Tx Buffer needs to be updated.

## 4.8 TTCAN Interrupt and Error Handling

The TT Interrupt Register **TTIR** consists of four segments. Each interrupt can be enabled separately by the corresponding bit in the TT Interrupt Enable register **TTIE**. The flags remain set until the Host clears them. A flag is cleared by writing a '1' to the corresponding bit position.

The first segment consists of flags **CER**, **AW**, **WT**, and **IWT**. Each flag indicates a fatal error condition where the CAN communication is stopped. With the exception of **IWT**, these error conditions require a re-configuration of the M\_TTCAN module before the communication can be restarted.

The second segment consists of flags **ELC**, **SE1**, **SE2**, **TXO**, **TXU**, and **GTE**. Each flag indicates an error condition where the CAN communication is disturbed. If they are caused by a transient failure, e.g. by disturbances on the CAN bus, they will be handled by the TTCAN protocol's failure handling and do not require intervention by the application program.

The third segment consists of flags **GTD**, **GTW**, **SWE**, **TTMI**, and **RTMI**. The first two flags are controlled by global time events (Level 0,2 only) that require a reaction by the application program. With a Stop Watch Event triggered by a rising edge on pin **m\_ttcn\_swt** internal time values are captured. The Trigger Time Mark Interrupt notifies the application that a specific Time\_Base\_Trigger is reached. The Register Time Mark Interrupt signals that the time referenced by **TTOCN.TMC** (Cycle, Local, or Global) equals time mark **TTMK.TM**. It can also be used to finish a Gap.

The fourth segment consists of flags **SOG**, **CSM**, **SMC**, and **SBC**. These flags provide a means to synchronize the application program to the communication schedule.

## 4.9 Level 0

TTCAN Level 0 is not part of ISO11898-4. This operation mode makes the hardware, that in TTCAN Level 2 maintains the calibrated global time base, also available for event-driven CAN according to ISO11898-1.

Level 0 operation is configured via **TTOCF.OM** = "11". In this mode the M\_TTCAN operates in event-driven CAN communication, there is no fixed schedule, the configuration of **TTOCF.GEN** is ignored. External event-synchronized operation is not available in Level 0. A synchronized time base is maintained by transmission of reference messages.

In Level 0 the trigger memory is not active and therefore needs not to be configured. The time mark interrupt flag (**TTIR.TTMI**) is set when the cycle time has reached **TTOCF.IRTO** • 0x200, it reminds the Host to set a transmission request for message buffer 0. The Watch\_Trigger interrupt flag (**TTIR.WT**) is set when the cycle time has reached 0xFF00. These values were chosen to have enough margin for a stable clock calibration. There are no further TT-error-checks.

Register time mark interrupts (**TTIR.RTMI**) are also possible.

The reference message is configured as for Level 2 operation. Received reference messages are recognized by the identifier configured in register TTRMC. For the transmission of reference messages only message buffer 0 may be used. The node transmits reference messages any time the Host sets a transmission request for message buffer 0, there is no reference trigger offset.

Level 0 operation is configured via:

- **TTRMC**
- **TTOCF** except **EVTP, AWL, GEN**
- **TTMLM** except **ENTT, TXEW**
- **TURCF**

Level 0 operation is controlled via:

- **TTOCN** except **NIG, TMG, FGP, GCS, TTMIE**
- **TTGTP**
- **TTTMK**
- **TTIR** excluding bits **CER, AW, IWT SE2, SE1, TXO, TXU, SOG** (no function)
- **TTIR** the following bits have changed function
  - **TTMI** not defined by trigger memory - activated at cycle time **TTOCF.IRTO** • 0x200
  - **WT** not defined by trigger memory - activated at cycle time 0xFF00

Level 0 operation is signalled via:

- **TTOST** excluding bits **AWE, WFE, GSI, GFI, RTO** (no function)

#### 4.9.1 Synchronizing

Figure 11 below describes the states and state transitions in TTCAN Level 0 operation. Level 0 has no In\_Gap state.

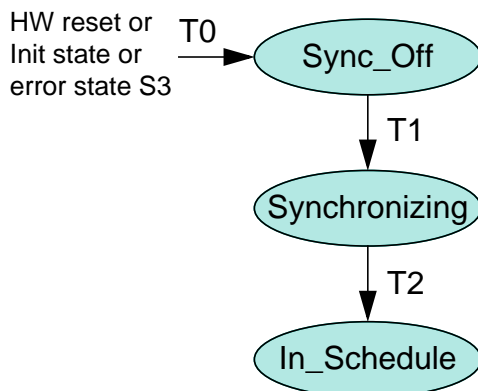

T0: transition condition always taking prevalence

T1: Init state left, cycle time is zero

T2: at least two successive reference messages observed  
(last reference message did not contain a set Disc\_Bit bit)

Figure 11 Level 0 schedule synchronization state machine

#### 4.9.2 Handling of Error Levels

During Level 0 operation only the following error conditions may occur:

- Watch\_Trigger\_Reached (S3), reached cycle time 0xFF00
- CAN\_Bus\_Off (S3)

Since no S1 and S2 error are possible, the error level can only switch between S0 (No Error) and S3 (Severe Error). In TTCAN Level 0 an S3 error is handled differently. When error level S3 is reached, both **TTOST.SYS** and **TTOST.MS** are reset, and interrupt flags **TTIR.GTE** and **TTIR.GTD** are set.

When error level S3 (**TTOST.EL** = "11") is entered, bus monitoring mode is, contrary to TTCAN Level 1 and Level 2, not entered. S3 error level is left automatically after transmission (time master) or reception (time slave) of the next reference message.

### 4.9.3 Master Slave Relation

Figure 12 below describes the master slave relation in TTCAN Level 0. In case of an S3 error the M\_TTCAN returns to state Master\_Off.

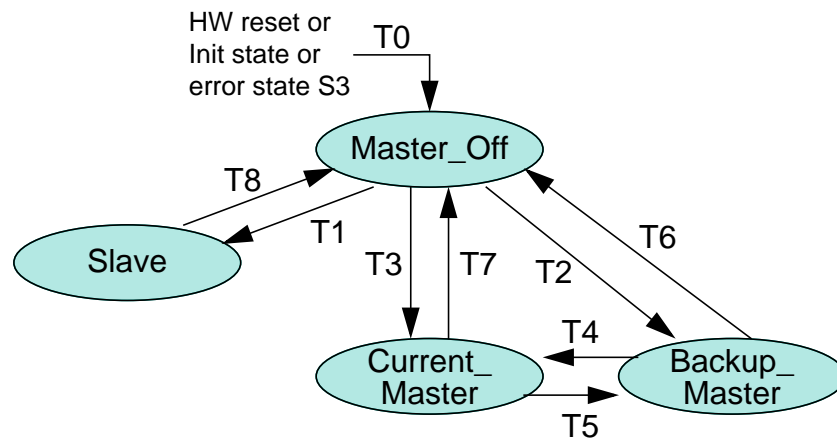

T0: transition condition always taking prevalence

T1: reference message observed when not potential time master

T2: reference message observed with master priority  $\neq$  own master priority, error state  $\neq$  S3

T3: reference message observed with master priority = own master priority, error state  $\neq$  S3

T4: reference message observed with own master priority

T5: reference message observed with master priority higher than own master priority

T6: error state S3

T7: error state S3

T8: error state S3

Figure 12 Level 0 master to slave relation

### 4.10 Asynchronous Serial Communication

When configured for TTCAN Level 1 or Level 2 operation, the M\_TTCAN time base can be used to switch access to the CAN bus for predefined time windows between M\_TTCAN and an ASC module (see Figure 13).

When an exclusive time window is assigned to the ASC module, the multiplexer connects the ASC module to the CAN transceiver. ASC transmission is free of CAN requirements for arbitration and fault confinement and therefore higher bit rates and effective payloads are possible.

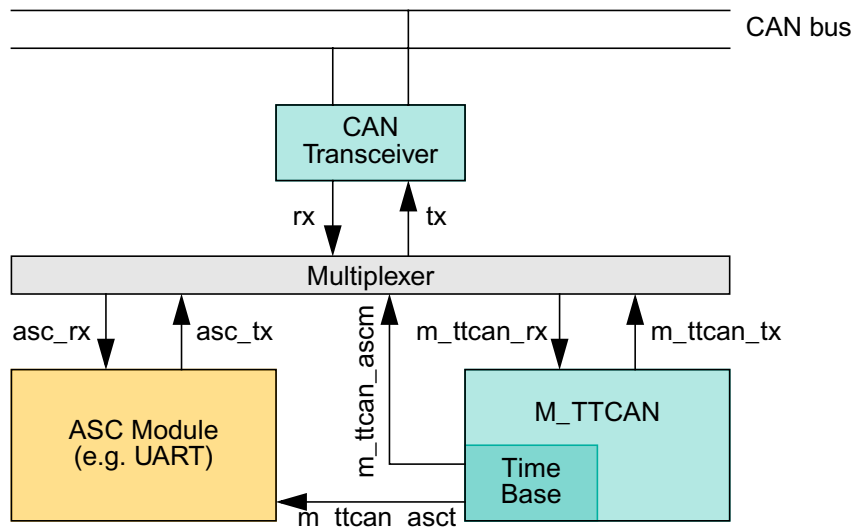

Figure 13 Asynchronous Serial Communication at CAN

Asynchronous serial operation is configured for each trigger element separately via **T0.ASC**. The M\_TTCAN's time base controls access to the CAN transceiver for M\_TTCAN or ASC module via output signal **m\_ttcan\_ascm**. Output signal **m\_ttcan\_asct** controls whether the ASC module is transmitter or receiver. For ASC transmission only one node in the network must be configured as transmitter while all other nodes are receivers.

With **T0.ASC = "00"** the ASC module is disconnected from the CAN bus (**m\_ttcan\_ascm = '0'**, **m\_ttcan\_asct = '0'**). When **T0.ASC = "01"** the ASC module is receiver (**m\_ttcan\_ascm = '1'**, **m\_ttcan\_asct = '0'**). When **T0.ASC = "10"** the ASC module is transmitter (**m\_ttcan\_ascm = '1'**, **m\_ttcan\_asct = '1'**).

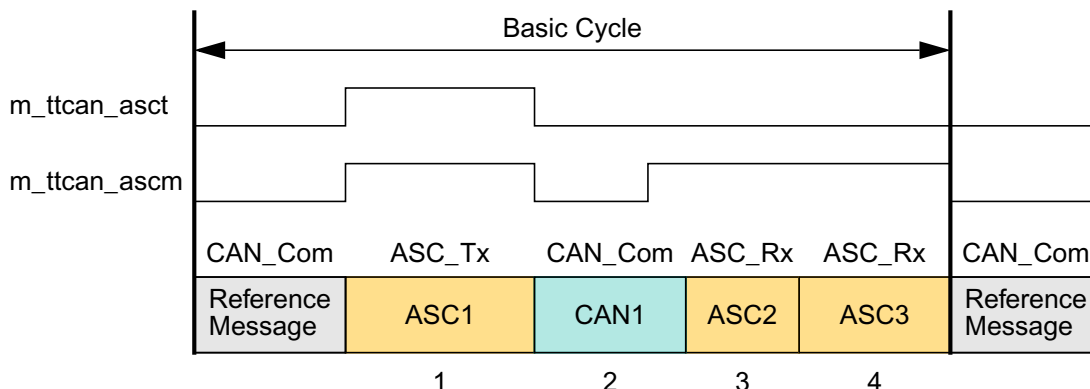

Figure 14 ASC@CAN operation

There are separate time windows for ASC transmission and reception. For each ASC time window there is one predefined transmitter, all other nodes are configured as receivers.

To start with an ASC window, the Host has to set **CCCR.ASM** during initialization. The bit is reset at the end of the first ASC window after the M\_TTCAN has finished initializing. During time-triggered operation **CCCR.ASM** is set by the M\_TTCAN at the beginning of an ASC window (trigger memory element with **T0.ASC** = "10", "11"). It is reset by each trigger memory element with **T0.ASC** = "00".

When **CCCR.ASM** is set, the CAN protocol controller

- sends no error/overload frames
- does not increment its error counters
- waits for Bus\_Idle (11 recessive bits) after it has detected an error or overload condition
- acknowledges valid frames
- may start the transmission of a frame after it has detected Bus\_Idle (11 recessive bits)

ASC mode operation is only entered when the M\_TTCAN is synchronization state In\_Schedule or In\_Gap (**m\_ttcn\_ascm** = '0' and **m\_ttcn\_asct** = '0' when not synchronized).

#### 4.11 Synchronization to external Time Schedule

This feature can be used to synchronize the phase of the M\_TTCAN's schedule to an external schedule (e.g. that of a second TTCAN network or FlexRay network). It is applicable only when the M\_TTCAN is current time master (**TTOST.MS** = "11").

External synchronization is controlled by event trigger input pin **m\_ttcn\_evt**. If bit **TTOCN.ESCN** is set, a rising edge at pin **m\_ttcn\_evt** the M\_TTCAN compares its actual cycle time with the target phase value configured by **TTGTP.CTP**.

Before setting **TTOCN.ESCN** the Host has to adapt the phases of the two time schedules e.g. by using the TTCAN gap control (see Section 4.3). When the Host sets **TTOCN.ESCN**, **TTOST.SPL** is set.

If the difference between the cycle time and the target phase value **TTGTP.CTP** at the rising edge at pin **m\_ttcn\_evt** is greater than 9 NTU, the phase lock bit **TTOST.SPL** is reset, and interrupt flag **TTIR.CSM** is set. **TTOST.SPL** is also reset (and **TTIR.CSM** is set), when another node becomes time master.

If both **TTOST.SPL** and **TTOCN.ESCN** are set, and if the difference between the cycle time and the target phase value **TTGTP.CTP** at the rising edge at pin **m\_ttcn\_evt** is less or equal 9 NTU, the phase lock bit **TTOST.SPL** remains set, and the measured difference is used as reference trigger offset value to adjust the phase at the next transmitted reference message.

**Note:** *The rising edge detection at pin **m\_ttcn\_evt** is enabled with the start of each basic cycle. The first rising edge triggers the compare of the actual cycle time with **TTGTP.CTP**. All further edges until the beginning of the next basic cycle are ignored.*



# Chapter 5.

## 5. Appendix

### 5.1 Register Bit Overview

Address	31	30	29	28	27	26	25	24	23	22	21	20	19	18	17	16	15	14	13	12	11	10	9	8	7	6	5	4	3	2	1	0	Symbol Reset Value
0x000	REL[4:0]				STEP[4:0]				SUBSTEP [4:0]				YEAR[4:0]				MON[7:0]				DAY[7:0]				CREL rrrd_ddd								
0x004	ETV[31:0]																															ENDN 8765_4321	
0x008	CUST[31:0]																															CUST t.b.d.	
0x010																								RX	TX[1:0]	LBCK	CAT	CAM	TAT	TAM	TEST 0000_0080		
0x014																								WDV[7:0]				WDC[7:0]				RWD 0000_0000	
0x018																								TEST	DAR	MON	CSR	CSA	ASM	CCE	INIT	CCCR 0000_0001	
0x01C												BRPE[3:0]			TSEG2[2:0]	TSEG1[3:0]	SJW[1:0]	BRPL[5:0]				BTP 0000_2301											
0x020												TCP[3:0]														TSS[1:0]	TSCC 0000_0000						
0x024												TSC[15:0]															TSCV 0000_0000						
0x028	TOP[15:0]																										TOS[1:0]	ETOC	TOCC FFFF_0000				
0x02C												TOC[15:0]															TOCV 0000_FFFF						

Table 72 M\_TTCAN Register Overview









## 5.2 Module Interface

The M\_TTCAN module's toplevel entity has the ports listed in the table below. More details on how to connect the M\_TTCAN to a customer-specific design can be found in [3] and [4].

<i>PORT</i>	<i>DIR</i>	<i>DOMAIN</i>	<i>DESCRIPTION</i>
Clocks and Reset			
m_ttcn_hclk	IN	HCLK	Host clock
m_ttcn_cclk	IN	CCLK	CAN clock
m_ttcn_reset	IN	ASYNC	module reset
Physical Layer Interface			
m_ttcn_rx	IN	CCLK	CAN receive input
m_ttcn_tx	OUT	CCLK	CAN transmit output
Generic Slave Interface			
m_ttcn_aei_sel	IN	HCLK	module select
m_ttcn_aei_w1r0	IN	HCLK	module write
m_ttcn_aei_byteen[3:0]	IN	HCLK	module byte enable
m_ttcn_aei_addr[8:2]	IN	HCLK	module address bus
m_ttcn_aei_wdata[31:0]	IN	HCLK	module data bus input
m_ttcn_aei_ready	OUT	HCLK	module ready
m_ttcn_aei_rdata[31:0]	OUT	HCLK	module data bus output
Generic Master Interface			
m_ttcn_aeim_ready	IN	HCLK	memory ready
m_ttcn_aeim_rdata[31:0]	IN	HCLK	memory data bus input
m_ttcn_aeim_berr[1:0]	IN	HCLK	Message RAM bit error
m_ttcn_aeim_sel	OUT	HCLK	memory select
m_ttcn_aeim_w1r0	OUT	HCLK	memory write
m_ttcn_aeim_addr[15:2]	OUT	HCLK	memory address bus, 32-bit word address
m_ttcn_aeim_wdata[31:0]	OUT	HCLK	memory data bus output
Miscellaneous			
m_ttcn_ext_ts[15:0]	IN	HCLK	external timestamp vector
m_ttcn_clkstop_req	IN	HCLK	clock stop request
m_ttcn_scanmode	IN	ASYNC	scan mode enable
m_ttcn_dis_mord	IN	HCLK	disable modification on read ( <b>ECR.CEL</b> , <b>PSR.LEC</b> )
m_ttcn_swt	IN	ASYNC	stop watch trigger
m_ttcn_evt	IN	ASYNC	event trigger
m_ttcn_int0	OUT	HCLK	interrupt 0
m_ttcn_int1	OUT	HCLK	interrupt 1
m_ttcn_clkstop_ack	OUT	HCLK	clock stop acknowledge
m_ttcn_soc	OUT	HCLK	start of cycle
m_ttcn_tmp	OUT	CCLK	trigger time mark interrupt pulse
m_ttcn_rtp	OUT	CCLK	register time mark interrupt pulse
m_ttcn_ascm	OUT	HCLK	ASC multiplexer control
m_ttcn_asct	OUT	HCLK	ASC transmit control

Table 73 M\_TTCAN Module Interface

<i>PORT</i>	<i>DIR</i>	<i>DOMAIN</i>	<i>DESCRIPTION</i>
Internal Flags			
m_ttcn_txbrp[31:0]	OUT	HCLK	Tx Buffer Request Pending ( <b>TXBRP</b> )
m_ttcn_cce	OUT	HCLK	Configuration Change Enable ( <b>CCCR.CCE</b> )

Table 73 M\_TTCAN Module Interface

### 5.3 Connection to external Message RAM

The M\_TTCAN is prepared for connection to a module-external single-ported or dual-ported 32-bit Message RAM via its Generic Master Interface. Depending on the system requirements additional logic for Message RAM arbitration, initialization, parity checking, or ECC has to be attached to the Message RAM. Further information with respect to Message RAM connection can be found in [3] and [4].



# List of Figures

Figure 1	M_TTCAN Block Diagram .....	2
Figure 2	Message RAM Configuration.....	56
Figure 3	Pin Control in Bus Monitoring Mode .....	66
Figure 4	Pin Control in Loop Back Modes .....	68
Figure 5	Standard Message ID Filter Path.....	72
Figure 6	Extended Message ID Filter Path .....	73
Figure 7	Example of mixed Configuration Dedicated Tx Buffers / Tx FIFO .....	76
Figure 8	Example of mixed Configuration Dedicated Tx Buffers / Tx Queue.....	77
Figure 9	Cycle Time and Global Time Synchronization.....	90
Figure 10	TTCAN Level 0 and Level 2 Drift Compensation .....	91
Figure 11	Level 0 schedule synchronization state machine.....	98
Figure 12	Level 0 master to slave relation .....	99
Figure 13	Asynchronous Serial Communication at CAN .....	100
Figure 14	ASC@CAN operation .....	100

# List of Tables

Table 1	M_TTCAN Register Map .....	5
Table 2	Core Release Register (addresses 0x000) .....	7
Table 3	Example for Coding of Revisions.....	7
Table 4	Endian Register (address 0x004) .....	8
Table 5	Test Register (address 0x010).....	8
Table 6	RAM Watchdog (address 0x14).....	9
Table 7	CC Control Register (address 0x18) .....	10
Table 8	Bit Timing & Prescaler Register (address 0x01C) .....	11
Table 9	Timestamp Counter Configuration (address 0x020).....	12
Table 10	Timestamp Counter Value (address 0x024) .....	12
Table 11	Timeout Counter Configuration (address 0x28) .....	13
Table 12	Timeout Counter Value (address 0x02C) .....	13
Table 13	Error Counter Register (address 0x40) .....	14
Table 14	Protocol Status Register (address 0x044).....	14
Table 15	Interrupt Register (address 0x50).....	16
Table 16	Interrupt Enable (address 0x54) .....	19
Table 17	Interrupt Line Select (address 0x58) .....	21
Table 18	Interrupt Line Enable (address 0x05C).....	22
Table 19	Global Filter Configuration (address 0x080).....	23
Table 20	Standard ID Filter Configuration (address 0x084) .....	24
Table 21	Extended ID Filter Configuration (address 0x088) .....	24
Table 22	Extended ID AND Mask (address 0x090).....	25
Table 23	High Priority Message Status (address 0x094) .....	25
Table 24	Rx FIFO 0 Configuration (address 0x0A0) .....	26
Table 25	Rx FIFO 0 Status (address 0x0A4) .....	27
Table 26	Rx FIFO 0 Acknowledge (address 0x0A8) .....	28
Table 27	Rx FIFO 1 Configuration (address 0x0B0) .....	28
Table 28	Rx FIFO 1 Status (address 0x0B4) .....	29
Table 29	Rx FIFO 1 Acknowledge (address 0x0B8) .....	30
Table 30	Tx Buffer Configuration (address 0x0C0) .....	31
Table 31	Tx FIFO/Queue Status (address 0xC4).....	32
Table 32	Tx Buffer Request Pending (address 0x0CC).....	33
Table 33	Tx Buffer Add Request (address 0x0D0).....	34
Table 34	Tx Buffer Cancellation Request (address 0x0D4) .....	34
Table 35	Tx Buffer Transmission Occurred (address 0x0D8).....	35
Table 36	Transmit Buffer Cancellation Finished (address 0x0DC) .....	35
Table 37	Tx Buffer Transmission Interrupt Enable (address 0x0E0) .....	36
Table 38	Tx Buffer Cancellation Finished Interrupt Enable (address 0x0E4).....	36
Table 39	Tx Event FIFO Configuration (address 0x0F0).....	37
Table 40	Tx Event FIFO Status (address 0x0F4).....	38
Table 41	Tx Event FIFO Acknowledge (address 0x0F8).....	38
Table 42	TT Trigger Memory Configuration (address 0x100).....	39
Table 43	TT Reference Message Configuration (address 0x104).....	39
Table 44	TT Operation Configuration (address 0x108) .....	40
Table 45	TT Matrix Limits (address 0x10C) .....	41
Table 46	TUR Configuration (address 0x110).....	42
Table 47	TT Operation Control (address 0x114).....	43
Table 48	TT Global Time Preset (address 0x118) .....	45
Table 49	TT Time Mark (address 0x11C).....	46
Table 50	TT Interrupt Register (address 0x120) .....	47
Table 51	TT Interrupt Enable (address 0x124).....	49

Table 52	TT Interrupt Line Select (address 0x128) .....	50
Table 53	TT Operation Status (address 0x12C).....	51
Table 54	TUR Numerator Actual (address 0x130) .....	53
Table 55	TT Local & Global Time (address 0x134).....	53
Table 56	TT Cycle Time & Count (address 0x138) .....	54
Table 57	TT Capture Time (address 0x13C).....	54
Table 58	TT Cycle Sync Mark (address 0x140) .....	55
Table 59	Rx FIFO Element.....	57
Table 60	Tx Buffer Element.....	58
Table 61	Tx Event FIFO Element .....	60
Table 62	Standard Message ID Filter Element.....	61
Table 63	Extended Message ID Filter Element .....	62
Table 64	Trigger Memory Element .....	63
Table 65	First byte of Level 1 reference message .....	79
Table 66	First four bytes of Level 2 reference message .....	80
Table 67	First four bytes of Level 0 reference message .....	80
Table 68	TUR Configuration Examples .....	82
Table 69	System Matrix Node A.....	86
Table 70	Trigger List Node A .....	86
Table 71	Number of Data Bytes transmitted with a reference messages.....	93
Table 72	M_TTCAN Register Overview .....	103
Table 73	M_TTCAN Module Interface .....	108